

Installation Manual  
For New Construction

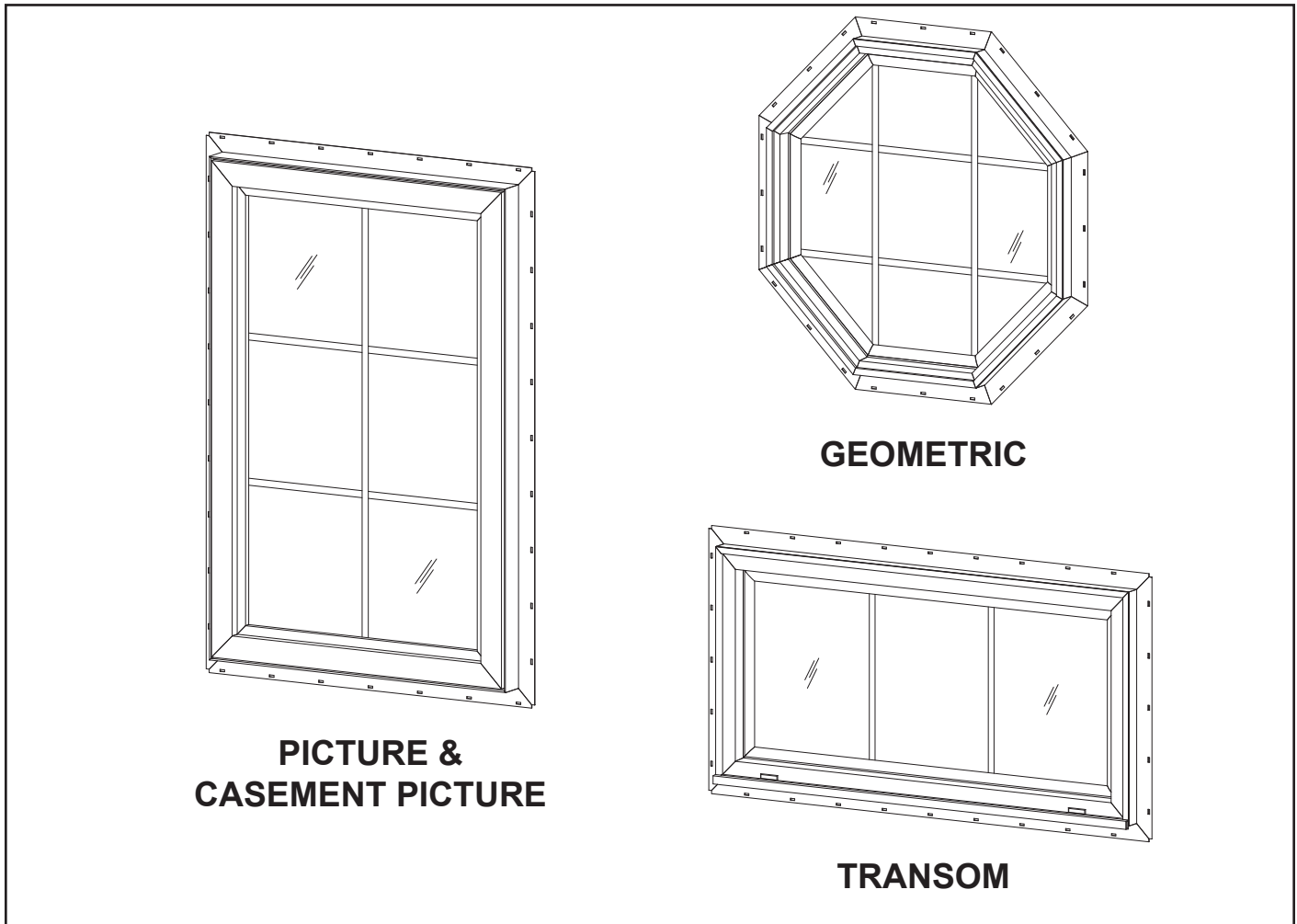

**PICTURE &  
CASEMENT PICTURE**

**GEOMETRIC**

**TRANSOM**

**SYSTEM DESCRIPTION**

- Variations: **StyleView Picture**                      **StyleView Contemporary Picture**  
                  **StyleView Casement Picture**            **StyleView Contemporary Casement Picture**  
                  **StyleView Transom**                        **StyleView Contemporary Transom**  
                  **StyleView Geometric**                      **StyleView Contemporary Geometric**
- 3-1/4" Overall Depth with Trim, 3-1/16" without Trim
- 3/4" Insulating Glazing
- Optional Screens
- Grille options available
  - Simulated Divided Lines
  - Sculptured Grids Between Glass
  - Flat Grids Between Glass
- Available in White, Tan, Stone, and Bronze Colors for StyleView;  
White, Tan, and Stone for StyleView Contemporary





**TABLE OF CONTENTS**

Installation Notes ..... Page ii & iii

Tools You'll Need ..... Page iv

**PREPARATION**

Measure Rough Opening and Install Sill Flashing ..... Page 1

**INSTALLATION**

Install Window ..... Page 2

**FINISHING**

Apply Perimeter Flashing ..... Page 3













**INSTALLATION NOTES**

1. Do not drop, roll or drag boxes of vinyl windows. Move and stack boxes with proper support to prevent distortion. If fork lifts are used, be especially careful about striking the boxes when lifting or moving.
2. Store in a dry, out of the way area. If rain exposure, condensation or any water contact is likely, then all packaging material should be removed. Wet packaging materials will discolor and may stain vinyl finishes.
3. All materials should be checked for quantity and quality upon receipt, YKK AP must be notified immediately of any discrepancies in shipment.
4. Check to make sure that you have the required shims, sealants, supplies, and tools necessary for the installation (not supplied by YKK AP).
5. Carefully check the openings and surrounding conditions that will receive your material. Remember, if the construction is not per the construction documents, it is your responsibility to notify the general contractor in writing. Any discrepancies must be brought to the general contractor's attention before you proceed with the installation.
6. Collect your shop drawings, materials, packing list, and this installation manual. Carefully review parts location, the sequence of installation, when you glaze it, and how you seal it. Installation instructions are of a general nature and may not cover every condition you will encounter. The shop drawings and/or installation manuals were prepared specifically for the product.
7. Any material substitutions must be of equal or greater quality.
8. Make certain that material samples have been sent for compatibility testing for all manufacturer's sealants involved. Make certain that sealants and backer rod have been installed in strict accordance with the manufacturer's recommendations and specifications.
9. System-to-structure fasteners are not supplied by YKK AP. Fasteners called out on shop drawings are to indicate minimum sizes for design loading.
10. If any questions arise concerning YKK AP products or their installation, contact YKK AP for clarification before proceeding.
11. YKK AP window installation is typically completed before drywall, flooring and other products which may still be in process. Take the extra time to wrap and protect the work produced.

## INSTALLATION NOTES

12. YKK AP StyleView windows are pre-finished, prefabricated, preassembled, and preglazed products, and must be protected against damage.
13. Concrete, mortar, plaster, muriatic acid and other alkaline and acid based construction and cleaning materials may be very harmful to window hardware and should be removed with water and mild soap immediately or permanent damage or staining of the finishes will occur. A spot test is recommended before any cleaning agent is used, and abrasive type cleaners must never be used.
14. Windows are never to be used as ladders, step stools, scaffolds, scaffold supports, or as pass through openings for materials.
15. All work must start from, and be referenced to benchmarks, offset lines and/or column centerlines established by the architectural drawings and the general contractor.
16. All windows must be installed plumb, square, level and true, and in accordance with approved shop drawings and these installation instructions.
17. Install all windows in accordance with their mark and type per approved shop drawings.
18. Do not use brick wash after windows are installed. Doing so will void the window warranty.
19. Windows should never be stored in an area where temperatures will exceed 140° F. Doing so will void the window warranty.
20. Windows should never be painted. Doing so will void the window warranty.
21. Buildings constructed prior to 1978 may contain lead paint which could be disturbed during replacement. For more information on proper management of lead paint, visit [www.epa.gov/lead](http://www.epa.gov/lead)
22. The glass has been specified by shop drawings and YKK AP is not responsible for conformance with local building codes other than to provide the approved glass. It is the installers' responsibility to ensure final compliance of the glazing with all applicable codes.
23. Check our website, [www.ykkap.com](http://www.ykkap.com), for the latest installation manual update prior to commencing work.

## TOOLS YOU'LL NEED

 <p>Tape measure</p>	 <p>Color-matched interior/exterior silicone window and trim sealant</p>
 <p>Level</p>	 <p>House wrap tape</p>
 <p>Power screwdriver and bits</p>	 <p>Felt paper flashing or equivalent (at least 6" wide)</p>
 <p>Galvanized roofing nails or #8 pan head corrosion-resistant screws (capable of penetrating at least 3/4" into the framing structure)</p>	 <p>Flashing (at least 6" wide)</p>
 <p>1/4" Shims</p>	 <p>Rubber mallet or hammer</p>
 <p>Caulk gun</p>	 <p>Remnant fiberglass insulation</p>

## PREPARATION

### STEP 1: Prepare the Opening

-Ensure the rough opening is 1/2" larger than the window to be installed and that the rough opening is plumb and square. See **Detail 1**.

**Note:** The frame size of the window does not include any protruding nail fins.

-Close and lock the vent to help keep the unit square.

- Apply flashing to the sill. See **Detail 2**.
- Apply a continuous bead of silicone caulk to the perimeter of the rough opening where the nail fin will make contact (no more than 1/4" from the edge of the rough opening.) Leave two 3" gaps for weepage at the sill flashing as shown.

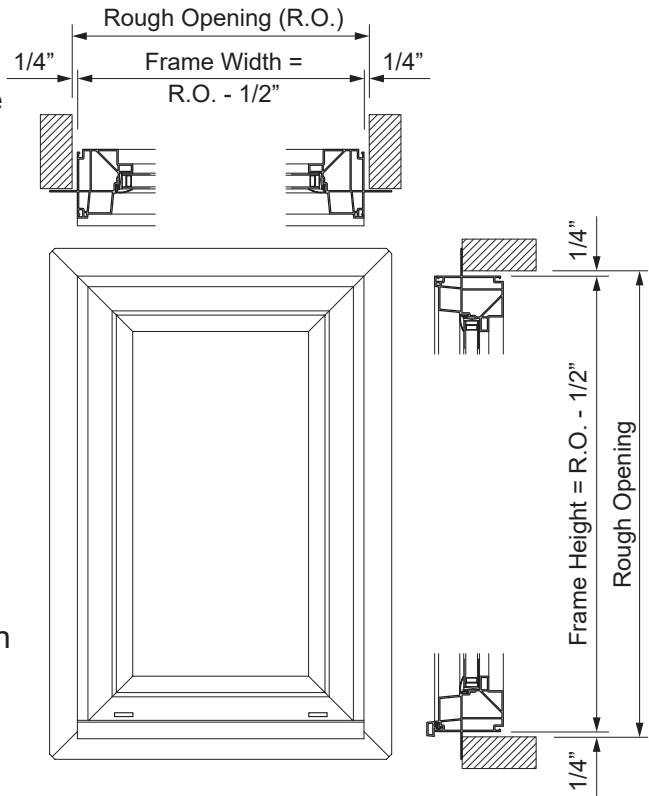

**DETAIL 1**  
Casement Window  
Shown, Awning  
Similar (Typ.)

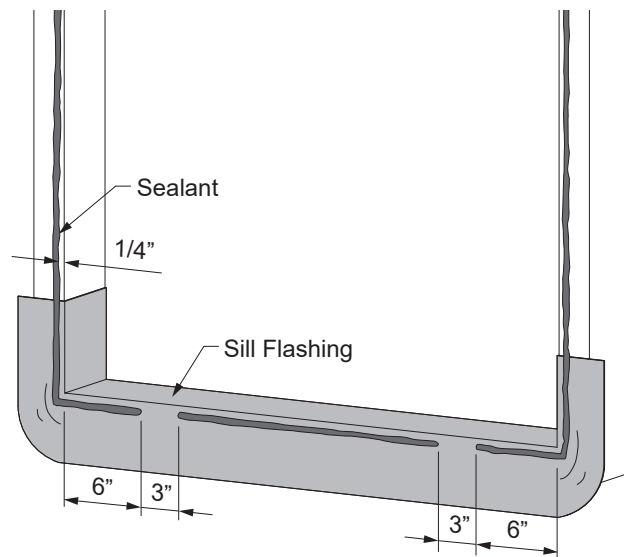

**DETAIL 2**

## INSTALLATION

### STEP 2: Install the Window

-Place 1/4" shims at either end and at every 12" maximum on center of the level sill plate. Place the window in the rough opening from the exterior, and center the unit in the opening, leaving a 1/4" gap between the unit and the rough opening on all sides. See **Detail 3**.

-Secure the unit by loosely fastening through the center of one nail slot at the top of one of the jambs using a 7/16" head x 1-1/2" galvanized roofing nail or a #8 pan head corrosion resistant screw. (Other nails and staples are prohibited.)

-Ensure the frame is plumb and the jambs straight. Shim at the top, bottom, and midpoint to correct any deflection.

-Finish nailing the unit using every other nail slot (every slot for DP50 or greater). Operate window to confirm proper installation.

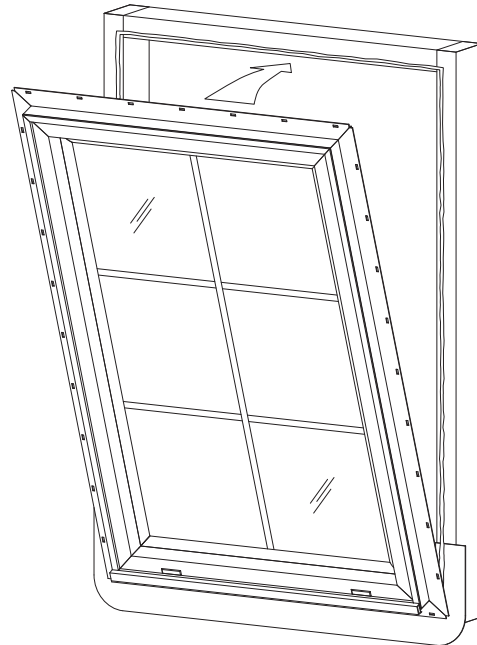

**DETAIL 3**



## FINISHING

### STEP 3: Finishing

- Apply flashing the perimeter of rough opening, covering the vertical nail fin. Apply the flashing at the head and overlap the jamb flashing on both sides. The head flashing should be caulked or taped on the top edge. See **Detail 4**.
- Use fiberglass insulation to insulate the cavity between the window and the rough opening structure.
- From the inside of the window, apply continuous sealant to the interior perimeter of the window sill and 12" up the jambs as shown in **Detail 5**.

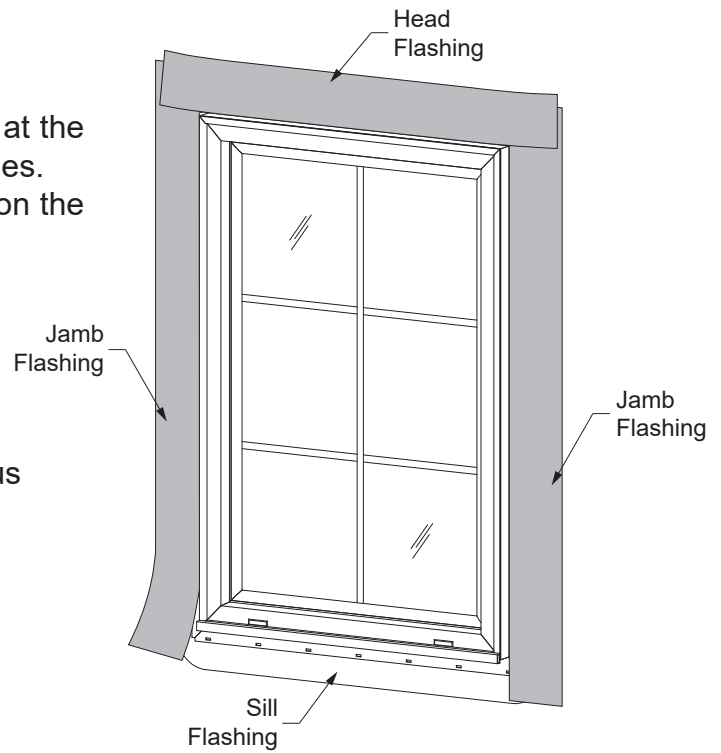

**DETAIL 4**

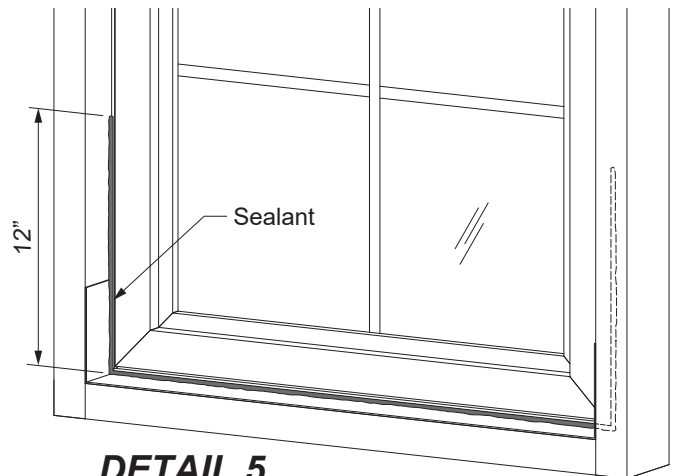

**DETAIL 5**

### Notes:

- Do not use expanding or spray-in foam products. If the installer used one of them, make sure jambs remain straight to ensure the operation of the window is not impeded.
- If using brick or stone exteriors, leave a 1/8" gap from the window to allow for brick and mortar expansion. Use a backer rod and silicone caulk to seal the gap.

 **YKK AP America Inc.**

**Headquarters**

101 Marietta Street NW  
Suite 2100  
Atlanta, Georgia 30303

**Residential Division**

4234 Ocmulgee East Blvd.  
Macon, Georgia 31217

[www.ykkap.com](http://www.ykkap.com)