

Installation Manual
For Replacement

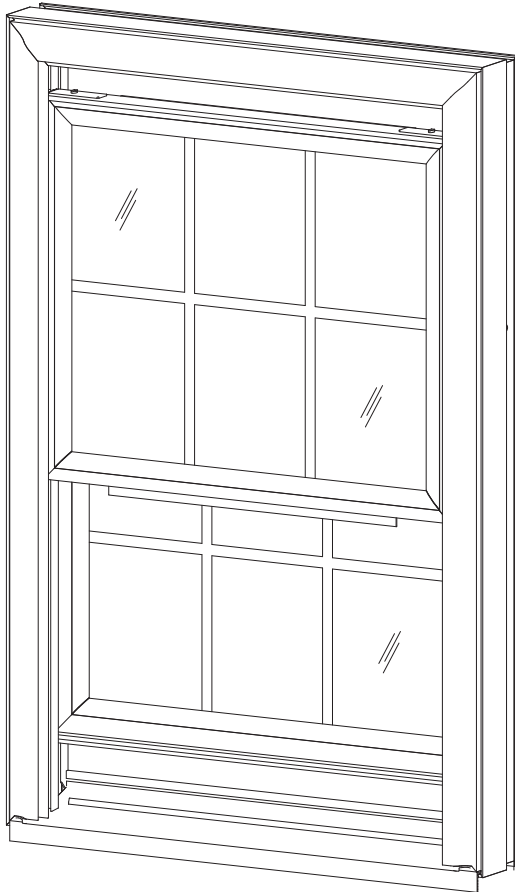

DOUBLE HUNG

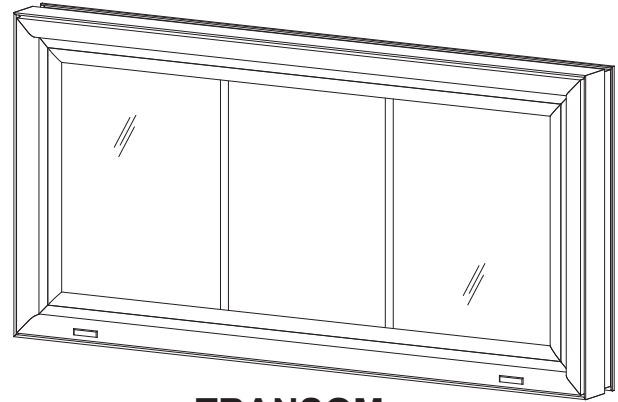

TRANSOM

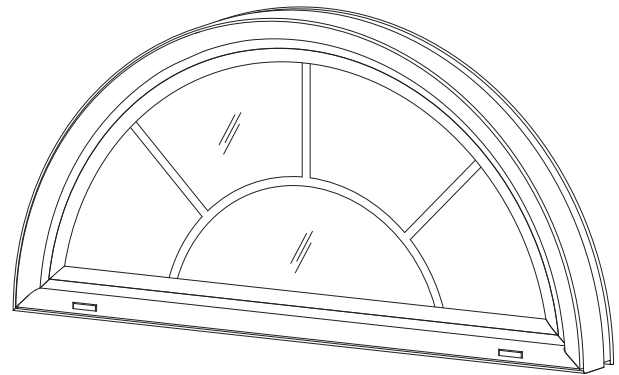

GEOMETRIC

SYSTEM DESCRIPTION

- Variations: **Single Hung, Double Hung & Fixed (Picture, Casement Picture, Transom & Geometric)**
- 3-1/4" Overall Depth
- Tilt-in Bottom Sash; Removable Upper Sash for Single Hung
- 3/4" Insulating Glazing
- Optional Screens
- Grille options available
 - Simulated Divided Lines
 - Sculptured Grids Between Glass
 - Flat Grids Between Glass
- Available in White, Tan, and Stone Colors



TABLE OF CONTENTS

Installation Notes	Page ii & iii
Tools You'll Need	Page iv
STEP 1	
Prepare the Opening: Removal of Old Window Sashes	Page 1
STEP 2	
Replace the Window.....	Pages 2 & 3
STEP 3	
Finishing and Notes.....	Page 3













INSTALLATION NOTES

1. Do not drop, roll or drag boxes of vinyl windows. Move and stack boxes with proper support to prevent distortion. If fork lifts are used, be especially careful about striking the boxes when lifting or moving.
2. Store in a dry, out of the way area. If rain exposure, condensation or any water contact is likely, then all packaging material should be removed. Wet packaging materials will discolor and may stain vinyl finishes.
3. All materials should be checked for quantity and quality upon receipt, YKK AP must be notified immediately of any discrepancies in shipment.
4. Check to make sure that you have the required shims, sealants, supplies, and tools necessary for the installation (not supplied by YKK AP).
5. Carefully check the openings and surrounding conditions that will receive your material. Remember, if the construction is not per the construction documents, it is your responsibility to notify the general contractor in writing. Any discrepancies must be brought to the general contractor's attention before you proceed with the installation.
6. Collect your shop drawings, materials, packing list, and this installation manual. Carefully review parts location, the sequence of installation, when you glaze it, and how you seal it. Installation instructions are of a general nature and may not cover every condition you will encounter. The shop drawings and/or installation manuals were prepared specifically for the product.
7. Any material substitutions must be of equal or greater quality.
8. Make certain that material samples have been sent for compatibility testing for all manufacturer's sealants involved. Make certain that sealants and backer rod have been installed in strict accordance with the manufacturer's recommendations and specifications.
9. System-to-structure fasteners are not supplied by YKK AP. Fasteners called out on shop drawings are to indicate minimum sizes for design loading.
10. If any questions arise concerning YKK AP products or their installation, contact YKK AP for clarification before proceeding.
11. YKK AP window installation is typically completed before drywall, flooring and other products which may still be in process. Take the extra time to wrap and protect the work produced.

INSTALLATION NOTES

12. YKK AP Precedence windows are pre-finished, prefabricated, preassembled, and preglazed products, and must be protected against damage.
13. Concrete, mortar, plaster, muriatic acid and other alkaline and acid based construction and cleaning materials may be very harmful to window hardware and should be removed with water and mild soap immediately or permanent damage or staining of the finishes will occur. A spot test is recommended before any cleaning agent is used, and abrasive type cleaners must never be used.
14. Windows are never to be used as ladders, step stools, scaffolds, scaffold supports, or as pass through openings for materials.
15. All windows must be installed plumb, square, level and true, and in accordance with approved shop drawings and these installation instructions.
16. Do not use brick wash after windows are installed. Doing so will void the window warranty.
17. Windows should never be stored in an area where temperatures will exceed 140° F. Doing so will void the window warranty.
18. Windows should never be painted. Doing so will void the window warranty.
19. Buildings constructed prior to 1978 may contain lead paint which could be disturbed during replacement. For more information on proper management of lead paint, visit www.epa.gov/lead
20. The glass has been specified by shop drawings and YKK AP is not responsible for conformance with local building codes other than to provide the approved glass. It is the installers' responsibility to ensure final compliance of the glazing with all applicable codes.
21. Comply with all local, state, and federal regulations when disposing or recycling of materials removed from the building structure.
22. Check our website, www.ykkap.com, for the latest installation manual update prior to commencing work.

TOOLS YOU'LL NEED

 <p>Tape measure</p>	 <p>Color-matched interior/exterior silicone window and trim sealant</p>
 <p>Level</p>	 <p>House wrap tape</p>
 <p>Power screwdriver and bits</p>	 <p>Felt paper flashing or equivalent (at least 6" wide)</p>
 <p>#8 pan head corrosion-resistant screws (capable of penetrating at least 3/4" into the framing structure)</p>	 <p>Flashing (at least 6" wide)</p>
 <p>1/4" Shims</p>	 <p>Rubber mallet or hammer</p>
 <p>Caulk gun</p>	 <p>Remnant fiberglass insulation</p>

PREPARATION

STEP 1: Prepare the Opening

Note: Prior to removing the old window, cross check the height and width of the new unit for correct fit.

From the inside of the house:

-Remove the old double hung window sash by removing the interior blind stop or interior trim. Use a utility knife to break the paint bond between the trim and the frame. This will allow for a more attractive finish with less potential for touch up. See **Details 1 & 2**.

Remove the bottom sash:

-Depending on the age of the unit being replaced, there may be a sash cord connected to a pulley system. Cut the sash cord to permit sash removal. See **Detail 3**.

Remove the top sash:

-If a parting stop exists, remove with a pry bar and chisel and repeat the same procedure for the bottom sash. (If installing from the outside of the house, remove the blind stop and use the procedure above starting with the top sash.)

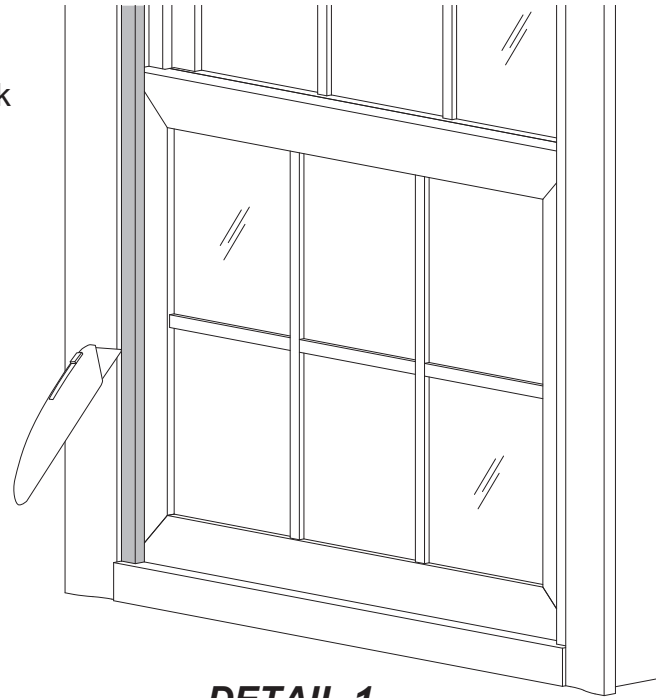

DETAIL 1



DETAIL 3

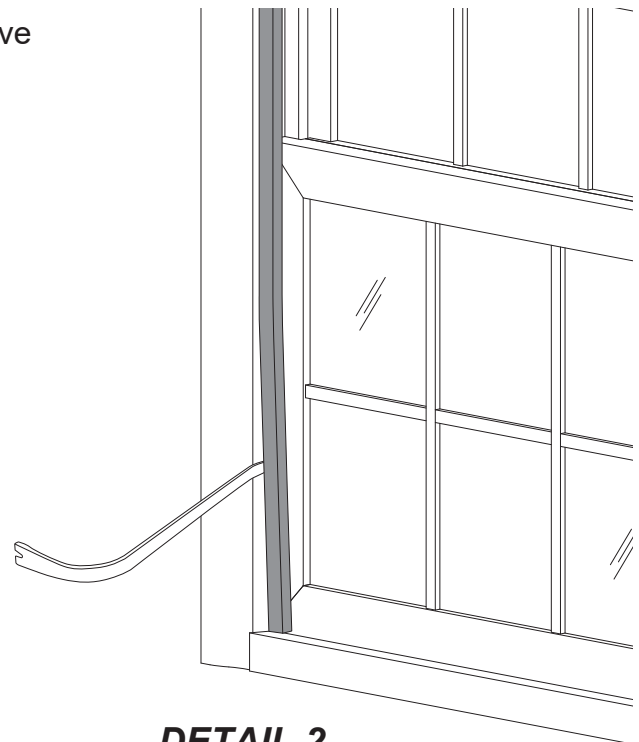

DETAIL 2

INSTALLATION**STEP 2: Replacing the Window**

Note: Prior to installing the new Precedence window, check the opening for squareness by performing corner-to-corner diagonal measurements. If the opening is out of square, adjust the opening by making additional cut backs to the rough opening in the appropriate areas.

-Place the window in the opening for a trial fit. For installations on top of sloped sills, measure directly from the bottom of the window to the sill directly below during the trial fit.

-Remove the window and cut the sill extender to this height and apply the window.

-If you are using a head expander, caulk the length of the back side, place in the head of the opening against the blind stops and secure the opening.

-Caulk the blind stops where the window will make contact at the head and jambs as shown in **Detail 4**.

-Rotate the replacement window into place and push firmly against the blind stops.

Note: All fasteners must be a minimum of #8, corrosion resistant flat head screws that must penetrate the subframe a minimum of 3/4.”

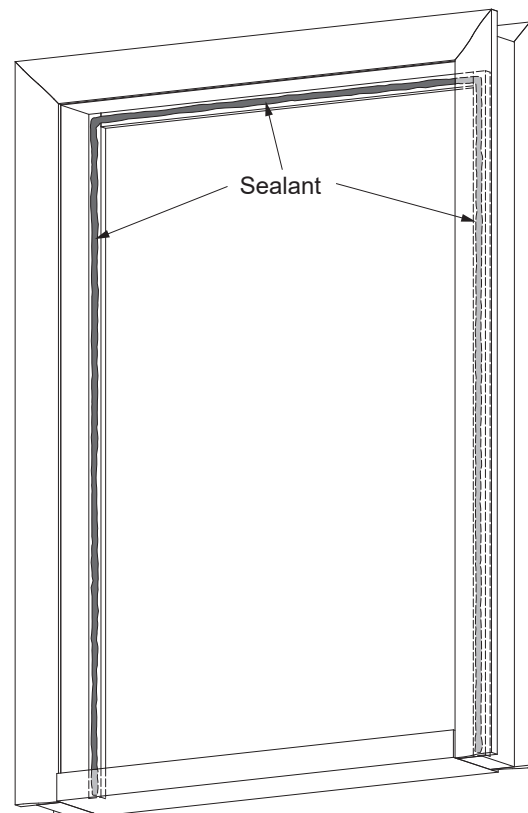
**DETAIL 4**

FINISHING

STEP 2 (Continued)

-Take diagonal measurements to assure the unit is square and adjust accordingly if necessary.

Note: For hung windows, opening the bottom sash approximately 1/2" will provide visual confirmation of the proper setting that the reveal between the frame and sash (A & B) are equal the entire width. See **Detail 5**.

-Fasten a screw through one of the top corners. Shims are required at each fastener location (top, middle, and bottom of each jamb).

Note: For double hung windows, use the jamb adjustment screws by turning the screw to make the jamb plumb. Double check by assuring an even weather-stripping reveal from top to bottom. A must equal B.

-Once the frame is anchored, take diagonal measurements again to assure the frame is square, and make adjustments accordingly.

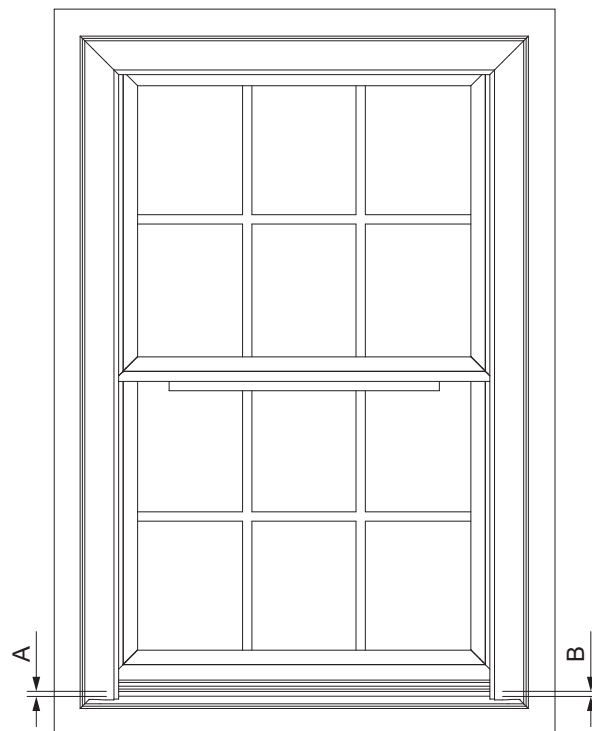

DETAIL 5

STEP 3: Finishing

-Check operation of the unit and make adjustments if necessary. Insulate as needed.

-Replace interior trim or exterior blind stop if installed from the outside.

-Caulk the bottom of the sill extender to the sill and the perimeter of the unit where it meets the blind stop on the outside.

See **Detail 6**.

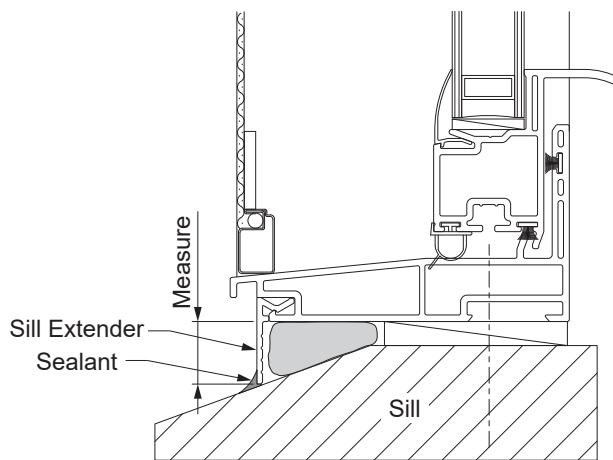

DETAIL 6

Notes:

-Do not use expanding or spray-in foam products. If the installer used one of them, make sure jambs remain straight to ensure the operation of the window is not impeded.

-If using brick or stone exteriors, leave a 1/8" gap from the window to allow for brick and mortar expansion. Use a backer rod and silicone caulk to seal the gap.

 **YKK AP America Inc.**

Headquarters

101 Marietta Street NW
Suite 2100
Atlanta, Georgia 30303

Residential Division

100 YKK AP Way
Macon, Georgia 31216

www.ykkap.com