

YOW 225 Window System

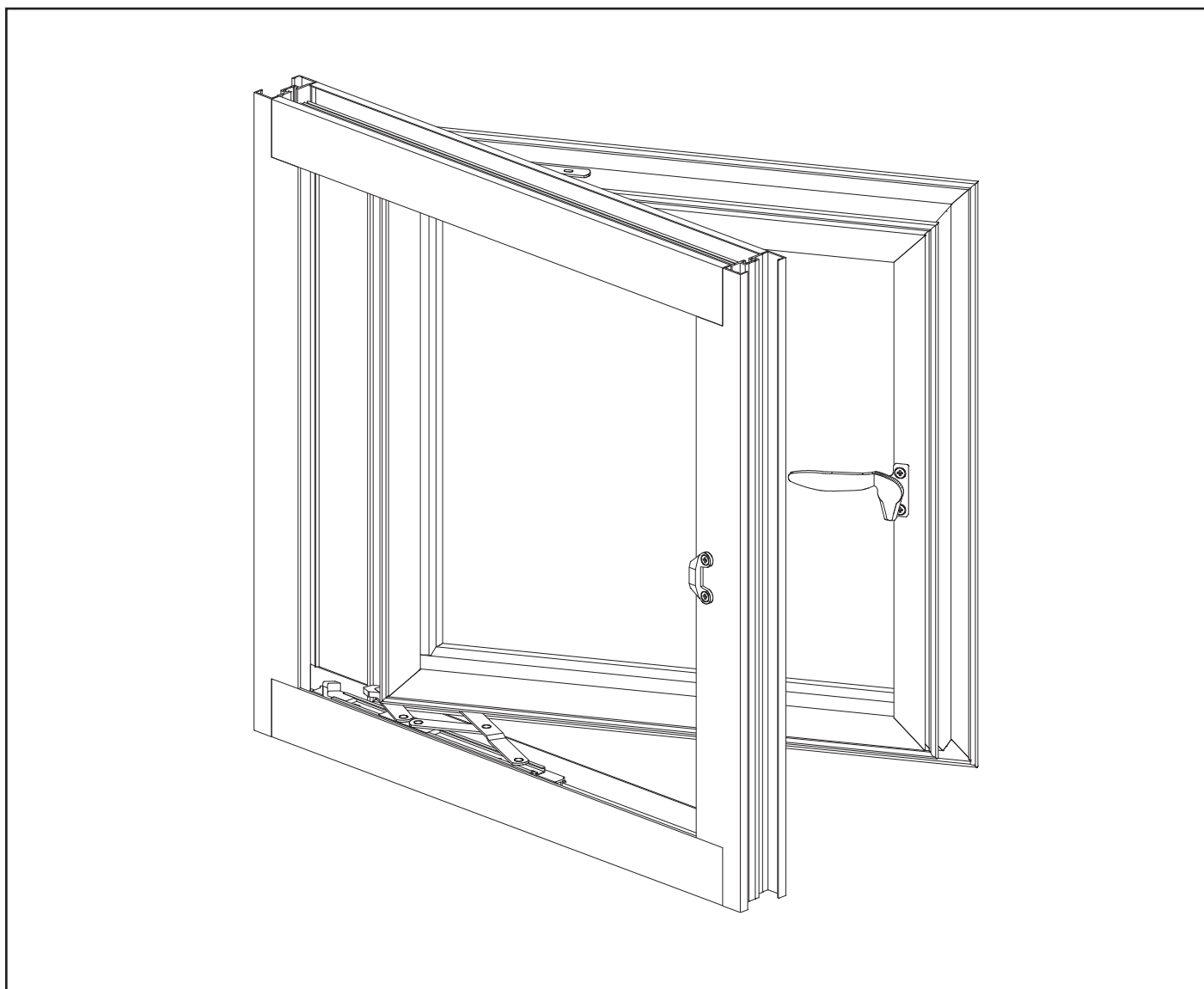

YOW 225 SYSTEM DESCRIPTION

- 2-1/4" Overall Depth
- Variations: Casement, Projected Vents, & Fixed Windows
- 1/4" & 1" Optional Insulating Glass
- Optional Screens

YOW 225 PERFORMANCE FEATURES

- AAMA/WDMA/CSA 101/I.S.A440-11
- AW-65 Rating (Operable)
- AW-100 Rating (Fixed)
- Factory Assembled & Sealed

Installation Manual

TABLE OF CONTENTS

Installation Notes Page ii & iii

INSTALLATION

Determine Window Reference Point Page 1
Determine Type of Anchors To Be Used Pages 1 & 2
Ventilator Installation & Adjustment..... Page 2
Accessible Window Installation Page 2

GLAZING

Calculating Glass Sizes..... Pages 3 to 4
Prep Casement Windows Page 5
Prep Fixed Windows..... Pages 6 & 7
Prep Projected Windows Page 8
Install Glass Pages 9 & 10

INSTALLATION OPTIONS

Install Optional Stacking Mullions / I-Mullion Pages 10

HARDWARE OPTIONS

Locking Point / Keeper Adjustment Page 11
Anchoring Parts List Page 12
Hardware Pages 13 to 17
Accessible Window Hardware Page 18

GLAZING ACCESSORIES

Glazing Chart..... Page 19
Glass Stops Page 19

INSTALLATION NOTES

1. Do not drop, roll or drag boxes of aluminum framing. Move and stack boxes with proper support to prevent distortion. If fork lifts are used, be especially careful about striking the boxes when lifting or moving.
2. Store in a dry, out of the way area. If rain exposure, condensation or any water contact is likely, then all packaging material should be removed. Wet packaging materials will discolor and may stain aluminum finishes and paints.
3. All materials should be checked for quantity and quality upon receipt, YKK AP must be notified immediately of any discrepancies in shipment. Check to make sure that you have the required shims, sealants, supplies, and tools necessary for the installation.
4. Carefully check the openings and surrounding conditions that will receive your material. Remember, if the construction is not per the construction documents, it is your responsibility to notify the general contractor in writing. Any discrepancies must be brought to the general contractor's attention before you proceed with the installation.
5. Collect your shop drawings, materials, packing list, and this installation manual. Carefully review parts location, the sequence of installation, when you glaze it, and how you seal it. Installation instructions are of a general nature and may not cover every condition you will encounter. The shop drawings and/or installation manuals were prepared specifically for the product.
6. Any material substitutions must be of equal or greater quality.
7. Make certain that material samples have been sent for compatibility testing for all manufacturer's sealants involved. Make certain that sealants have been installed in strict accordance with the manufacturer's recommendations and specifications.
8. Consult sealant manufacturer for proper sealant and backer rod selection.
9. Remember to isolate, in a approved manner, all aluminum from uncured masonry or other incompatible materials.
10. System-to-structure fasteners are not supplied by YKK AP. Fasteners called out on shop drawings are to indicate minimum sizes for design loading.
11. If any questions arise concerning YKK AP products or their installation, contact YKK AP for clarification before proceeding.

INSTALLATION NOTES

12. YKK AP window installation is typically completed before drywall, flooring and other products which may still be in process. Take the extra time to wrap and protect the work produced.
13. Cutting tolerances are plus or minus one thirty second unless otherwise specified.
14. YKK AP Model YOW 225 windows are prefinished, prefabricated, and preassembled products, and must be protected against damage.
15. Concrete, mortar, plaster, muriatic acid and other alkaline and acid based construction and cleaning materials may be very harmful to window finishes and should be removed with water and mild soap immediately or permanent damage or staining of the finishes will occur. A spot test is recommended before any cleaning agent is used, and abrasive type cleaners must never be used.
16. Windows are never to be used as ladders, step stools, scaffolds or scaffold supports.
17. All work must start from, and be referenced to benchmarks, offset lines and/or column centerlines established by the architectural drawings and the general contractor.
18. All windows must be installed plumb, square, level and true, and in accordance with approved shop drawings and these installation instructions.
19. Glass and glazing building codes governing the design and use of products vary widely. YKK AP America Inc. does not control the selection of products, product configurations, operating hardware and function, or glazing materials, and YKK AP assumes no responsibility for these design considerations. It is the responsibility of the design professional, owner, architect, specifier, general contractor, and the installer to make these selections in strict accordance with all applicable codes.
20. Do not fasten ceiling support angles, blind pockets, drapery tracks, convector covers or stools to the windows or the receptors. The window system is not designed to support the additional load and must be free to expand and contract under normal thermal cycling conditions.
21. Check our website, www.ykkap.com, for the latest installation manual update prior to commencing work.

INSTALLATION

STEP 1 DETERMINE WINDOW REFERENCE POINT

Establish the window reference lines or the exterior/interior plane of the windows to be installed using either bench marks, offset lines, or column centerlines provided by the general contractor and referenced on the shop drawings. Use the established reference points to determine the installation points for each window opening at the head, jambs, and sill.

Inspect window frame joinery to ensure they have not been stressed or broken during transportation and handling to the opening. Reseal any stressed or broken seals with Tremsil 600 or equal.

STEP 2 DETERMINE THE TYPE OF WINDOW ANCHORS TO BE USED

The type of window anchoring used will depend upon the job conditions and the installer's preference. No. 10 fasteners are to be the minimum size used; consult the shop drawings and engineering calculations as the project conditions may require larger fasteners.

See **Details 1 & 2**.

Location of fasteners:

- A maximum of 3" from the corner of all frames and receptors.
- At 15" on center staggered from the front to the back.
- A maximum of 3" on each side from the centerline of ventilator locking points.
- Shim solidly between the window and building substrate and do not "open" window joinery when anchoring.
- Add anchorage at hinges, especially butt hinges.

Note: For fabrication and installation of head receptors, sill flashings, strap anchors, steel twist anchors, edge clip anchors, and trim & clip anchors, refer to the **Window Accessories Installation Manual**.

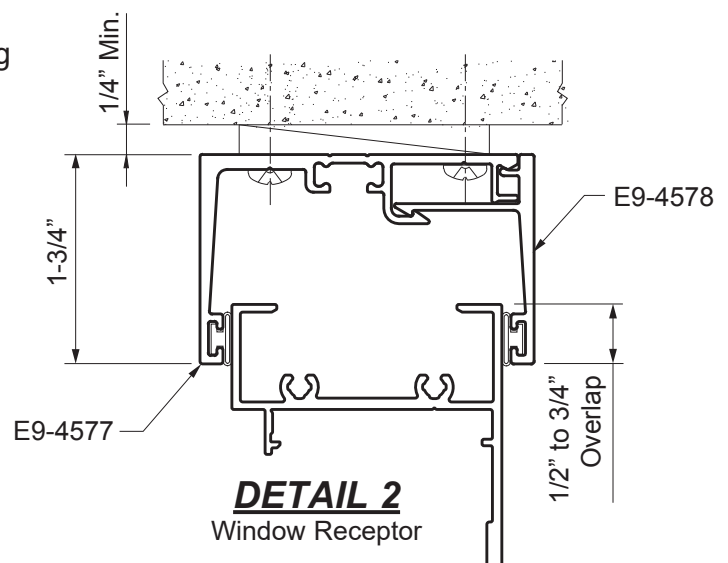
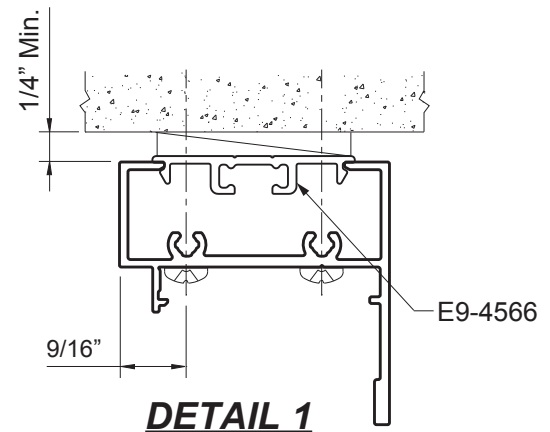

INSTALLATION

STEP 2 (Continued)

DETERMINE THE TYPE OF WINDOW ANCHORS TO BE USED

Refer to the specific fastener manufacturer's recommendations for proper edge distance, embedment, and spacing for masonry applications. Seal all screw heads that penetrate the framing and make water tight. See **Detail 3**.

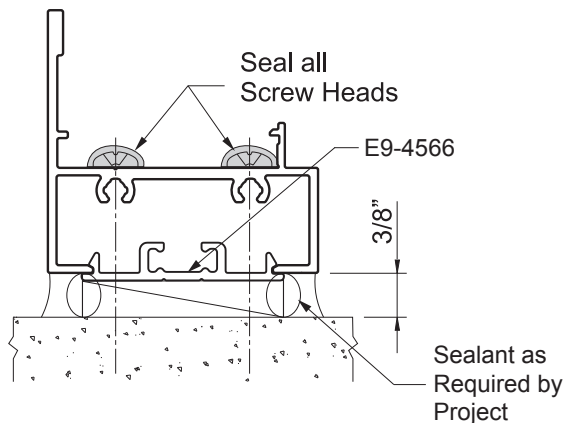

DETAIL 3

STEP 3

VENTILATOR INSTALLATION AND ADJUSTMENT

- All operating hardware and components must be checked for proper alignment, margins, and operation.
 - If necessary adjust the hinges, keepers, friction arms and pivots to ensure the proper operation of locking devices and the compression of the weather seal.
 - Push hinges as close to the hinge jamb as possible and as tight towards the interior as possible.
 - Check gasket compression between frame and vent. Insert a piece of paper between the frame and vent. Close the vent. Moderate resistance to pulling the paper should be felt. Check all four sides of the vent.
 - All hardware must be cleaned to provide smooth operation.
- See **Page 11** for multi-point lock adjustment.

Note: To re-install 4-bar hinges after loosening or removal, tighten the fasteners by hand using a screwdriver or allen wrench, depending on fastener type. Aggressive over-tightening may strip the fasteners.

STEP 4

ACCESSIBLE WINDOW INSTALLATION

- Accessible Windows require additional care during installation and must be installed plumb, square, and level without twisting, bowing, or racking.
- Final adjustments may be required. Refer to the **Window Products Maintenance Manual** for adjustment directions.

Caution: Never use a power screw driver to adjust and/or replace hardware components.

Refer to the Americans with Disabilities Act and Fair Housing Act for more information regarding compliance requirements.

CALCULATING GLASS SIZES

ELEVATION FIXED WINDOW				
		FIXED GLASS SIZE	GLASS W	$FW - 3 \frac{3}{8}'' [85.7\text{mm}]$
	GLASS H	$FH - 3 \frac{3}{8}'' [85.7\text{mm}]$	$h1, h2 - 2 \frac{15}{16}'' [74.6\text{mm}]$	$FH - 3 \frac{3}{8}'' [85.7\text{mm}]$

ELEVATION CASEMENT OUTSWING INSWING				
		VENT GLASS SIZE	GLASS W	$FW - 5 \frac{7}{8}'' [149.2\text{mm}]$
	GLASS H	$FH - 5 \frac{7}{8}'' [149.2\text{mm}]$	$h1 - 5 \frac{7}{16}'' [138.1\text{mm}]$	$h2 - 5 \frac{7}{16}'' [138.1\text{mm}]$
FIXED GLASS SIZE	GLASS W	N/A	$FW - 3 \frac{3}{8}'' [85.7\text{mm}]$	$FW - 3 \frac{3}{8}'' [85.7\text{mm}]$
	GLASS H	N/A	$h2 - 2 \frac{3}{8}'' [60.3\text{mm}]$	$h1 - 2 \frac{3}{8}'' [60.3\text{mm}]$

ELEVATION CASEMENT OUTSWING INSWING				
		VENT GLASS SIZE	GLASS W	$w1 - 5 \frac{7}{16}'' [138.1\text{mm}]$
	GLASS H	$FH - 5 \frac{7}{8}'' [149.2\text{mm}]$	$FH - 5 \frac{7}{8}'' [149.2\text{mm}]$	$FH - 5 \frac{7}{8}'' [149.2\text{mm}]$
FIXED GLASS SIZE	GLASS W	$w2 - 2 \frac{3}{8}'' [60.3\text{mm}]$	$w2 - 1 \frac{3}{8}'' [34.9\text{mm}]$	N/A
	GLASS H	$FH - 3 \frac{3}{8}'' [85.7\text{mm}]$	$FH - 3 \frac{3}{8}'' [85.7\text{mm}]$	N/A

NOTE: GLASS BITE = 1/2" (for 1/4" & 1" Glazing)

CALCULATING GLASS SIZES

ELEVATION							
VENT GLASS SIZE	GLASS W	FW – 5 7/8" [149.2mm]	FW – 5 7/8" [149.2mm]	w1,w2 – 5 7/16" [138.1mm]			
	GLASS H	FH – 5 7/8" [149.2mm]	h1 – 5 7/16" [138.1mm]	h1 – 5 7/16" [138.1mm]			
FIXED GLASS SIZE	GLASS W	N/A	FW – 3 3/8" [85.7mm]	w1,w2 – 2 15/16" [74.6mm]			
	GLASS H	N/A	h2 – 2 3/8" [60.3mm]	h2 – 2 3/8" [60.3mm]			

ELEVATION					
VENT GLASS SIZE	GLASS W	FW – 5 7/8" [149.2mm]	FW – 5 7/8" [149.2mm]		
	GLASS H	h2 – 5 7/16" [138.1mm]	h1,h2 – 5 7/16" [138.1mm]		
FIXED GLASS SIZE	GLASS W	FW – 3 3/8" [85.7mm]	N/A		
	GLASS H	h1 – 2 3/8" [60.3mm]	N/A		

NOTE: GLASS BITE = 1/2" (for 1/4" & 1" Glazing)

GLAZING

STEP 5A PREP CASEMENT WINDOWS

Casement windows require “Corner Blocking” for proper operation.

1. Verify that the frame and vent are properly aligned with a 1/8” margin around the entire perimeter of the vent.
2. Remove the glazing beads and clean the exterior glazing leg with an approved cleaning agent using the “two cloth” cleaning method.
3. Install exterior glazing tape, E2-0670, on all four sides:
 - Leave a 1/8” gap between the edge of the tape and the edge of the ventilator.
 - Make certain that the corners of the tape do not overlap as this will prevent full contact around the perimeter of the glass.
4. Peel back the tape adhesive backing 3” to 4” at each corner and fold them towards the inside of the vent.

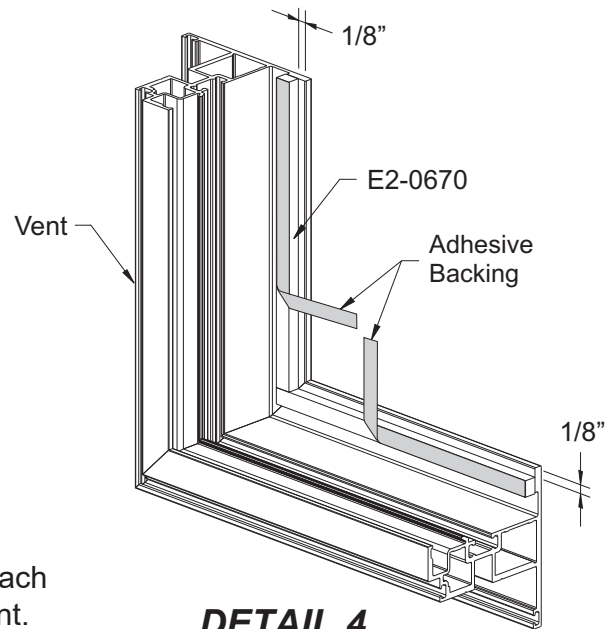

DETAIL 4

See **Detail 4**.

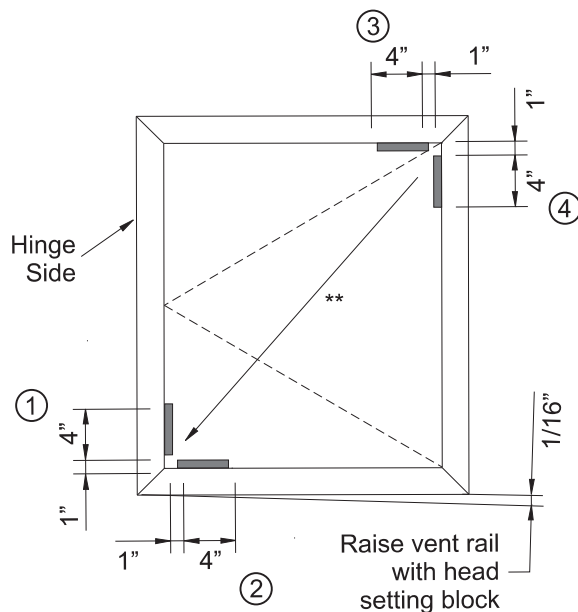

DETAIL 5

5. Install setting blocks at locations 1,2 and 4.
6. If bench glazing, make sure that the casement vent is fully supported from underneath before proceeding.
7. Unlock the ventilator lock and install a setting block at location 3.
8. Change setting blocks as required to square up the vent.
9. Raise up the vent’s locking rail 1/16” and shim so that as the setting blocks compress the locks will align properly.

See **Detail 5**.

Finish glazing in accordance with standard glazing instructions in **Steps 6 & 7** on **Page 9 & 10**.

** Glass weight is transferred to bottom corner and hinge.

GLAZING**STEP 5B
PREP FIXED WINDOWS****Optional Weep Hole Baffles when using Sill Flashing:**

- Prior to field glazing fixed lites, adhere a weep baffle (E2-0772) with sealant, over the weep hole in the sill, centered on the weep hole.
- Tool the excess sealant after application.

See **Detail 6**.

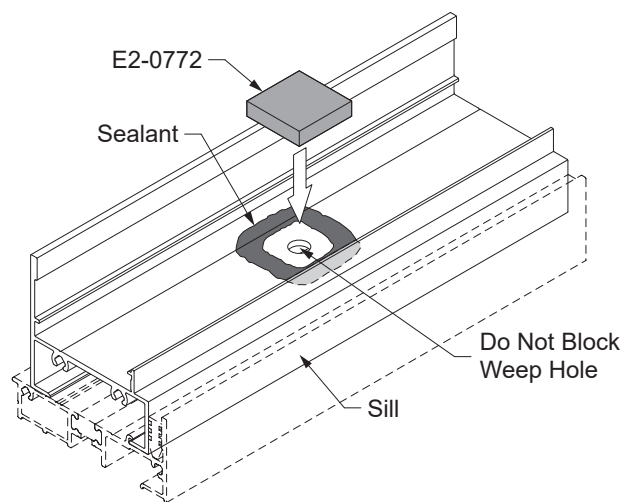
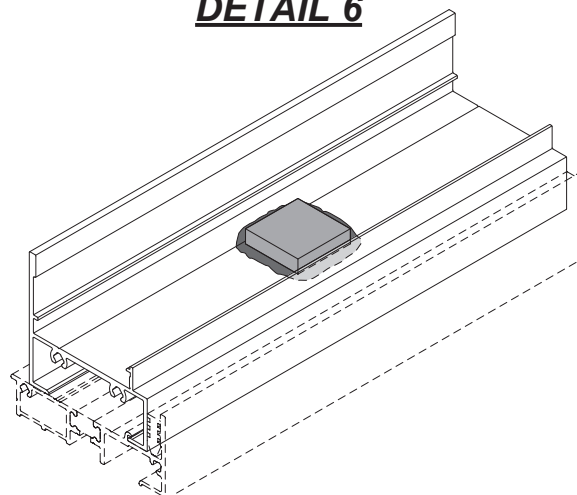
**DETAIL 6**

GLAZING

STEP 5B (Continued) PREP FIXED WINDOWS

1. Verify that the frame is square.
2. Remove the glazing beads and clean the exterior glazing leg with an approved cleaning agent using the “two cloth” cleaning method. Also clean the interior corners of the frame glazing pocket.
3. Apply and tool sealant to the interior corners of the frame glazing pocket as shown in **Detail 7**.
4. Prior to installing exterior glazing tape, E2-0670, wipe the sealant off where the tape is to be adhered.
5. Install exterior glazing tape on all four sides:
 - Leave a 1/8” gap between the edge of the tape and the edge of the ventilator/frame.
 - Make certain that the corners of the tape do not overlap as this will prevent full contact around the perimeter of the glass.
6. Peel back the tape adhesive backing 3” to 4” at each corner and fold them towards the inside of the vent/window.
7. Install setting blocks at 1/8 points (at least 6” from jambs) for fixed frames and intermediate horizontal mullions.
8. Install (2) side blocks at 1/4 points for fixed frames as shown.

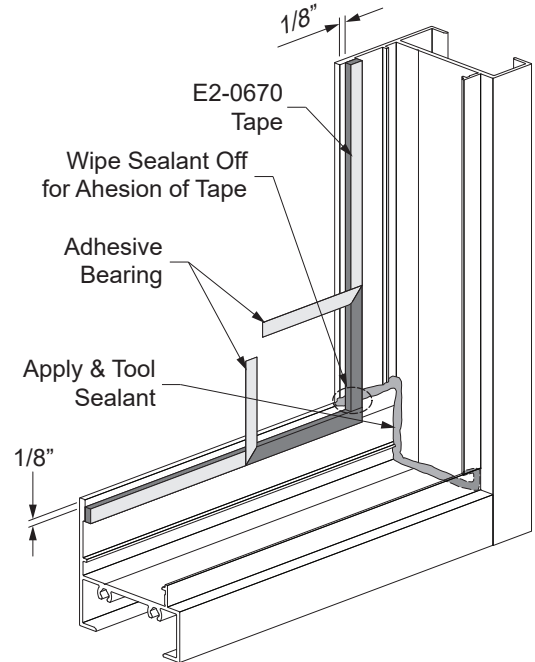

DETAIL 7

See **Detail 8**.

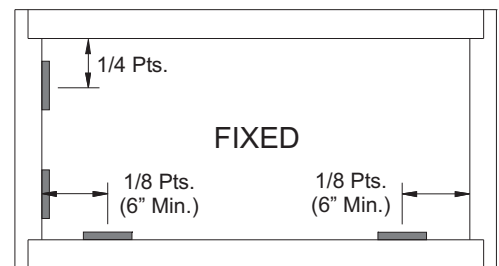

DETAIL 8

GLAZING

**STEP 5C
PREP PROJECTED WINDOWS**

1. Verify that the frame and vent are properly aligned with a 1/8" margin around the entire perimeter of the vent.
2. Remove the glazing beads and clean the exterior glazing leg with an approved cleaning agent using the "two cloth" cleaning method.
3. Install exterior glazing tape, E2-0670, on all four sides:
 - Leave a 1/8" gap between the edge of the tape and the edge of the ventilator/frame.
 - Make certain that the corners of the tape do not overlap as this will prevent full contact around the perimeter of the glass.
4. Peel back the tape adhesive backing 3" to 4" at each corner and fold them towards the inside of the vent/window.

See **Detail 9**.

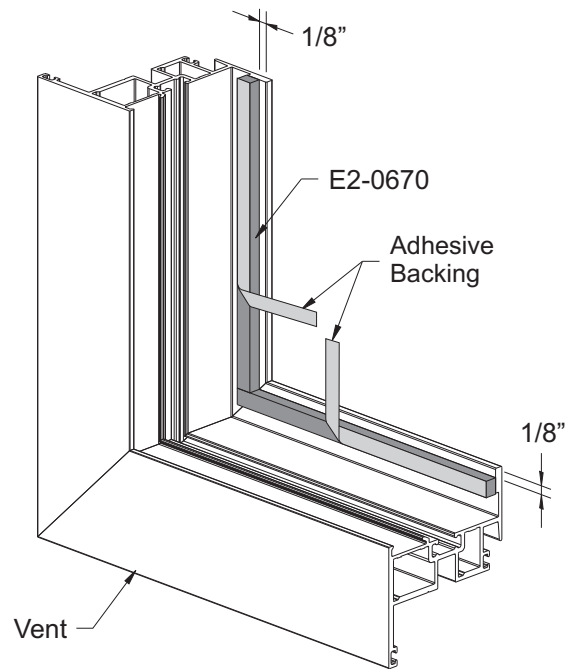

DETAIL 9

5. Install setting blocks at 1/8 points (at least 6" from jambs) for vents and intermediate horizontal mullions.
6. Install (1) side block at 1/3 points for projected vents as shown.

See **Detail 10**.

Finish glazing in accordance with standard glazing instructions in **Steps 6 & 7 on Page 9 & 10**.

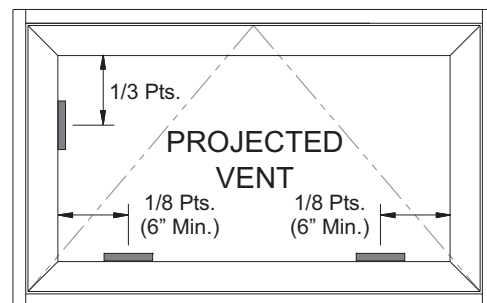

DETAIL 10

VENT GLAZING

STEP 6 INSTALL GLASS

1. Center the glass and carefully set the unit down onto the setting blocks.
2. From the exterior of the window gently pull the folded adhesive backing ends to remove it and adhere the glass to glazing tape.

See **Detail 11**.

STEP 6A FOR PRESET INTERIOR GASKETS ONLY

3. Press the glass firmly against the exterior glazing tape.
4. Cut interior preset gasket to the length of the glass stop.
5. Install the preset gasket by sliding it into the glass stops.
6. Snap in the interior glass stops into place, starting with the horizontals, then the verticals.

See **Detail 12**.

STEP 6B FOR WEDGE INTERIOR GASKETS ONLY

3. Press glass firmly against the exterior glazing tape.
4. Install the interior glass stops.
5. Cut interior wedge gasket to the day light opening dimension plus 1/8" per foot of D.L.O.
6. Install the wedge gasket by first installing each end and then the center of the gasket; push in the remainder of the gasket working from the center toward each end.

See **Detail 13** on **Page 10**.

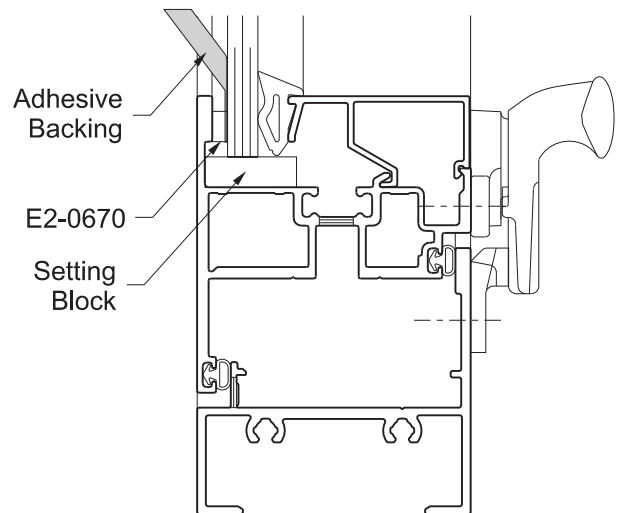

DETAIL 11

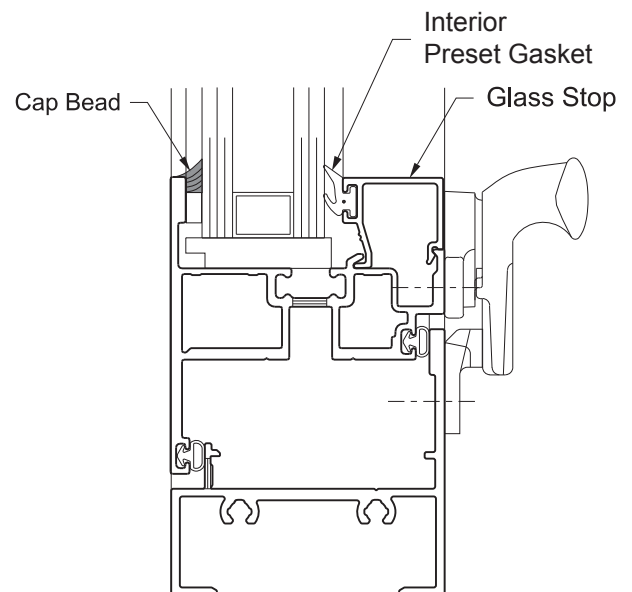

DETAIL 12

GLAZING

**STEP 7
APPLY CAP BEAD
(For Fixed or Vent Glazing)**

1. Apply Tremco Tremsil® 600 sealant or equal to the joint between the glass and glazing leg. When applying sealant vertically, start at the bottom and work your way up. Make sure the sealant completely fills the joint. Cover the aluminum glazing leg with sealant.
2. Using a non-scratching implement, tool the sealant immediately after running the bead. Exert positive pressure to ensure that the sealant makes complete contact with all surfaces. Cap bead should cover at least 50% of the external glazing leg.

Be careful not to remove too much sealant.

See **Details 12 & 13**.

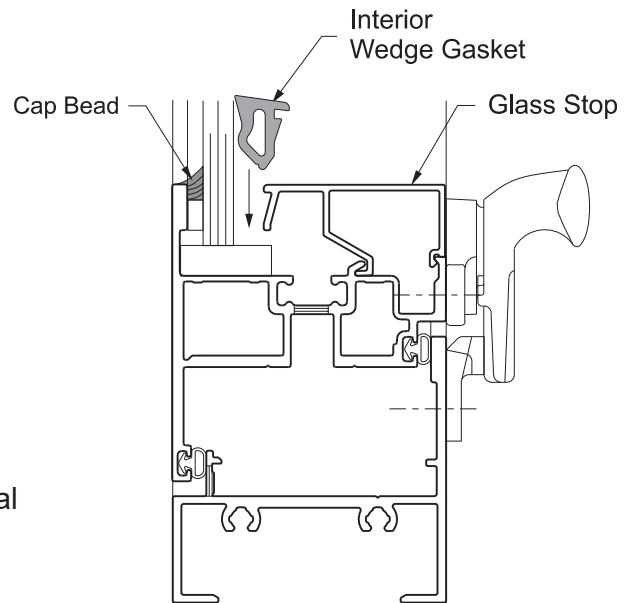

DETAIL 13

INSTALLATION OPTIONS

**STEP 8 (Optional)
INSTALL OPTIONAL STACKING MULLIONS / I-MULLION**

Refer to the **Window Accessories Installation Manual** for installation of optional stacking mullions or I-mullions.

HARDWARE

STEP 9A MULTI-POINT LOCK ADJUSTMENT (FOR OUTSWING WINDOWS ONLY)

Adjust flushness of window keepers as necessary.

1. Neutral as factory installed.

See **Detail 14**.

2. Use 3/16" hex key to rotate lock point.
 - A. Turn clockwise to tighten seal.
 - B. Turn counter-clockwise to loosen seal.

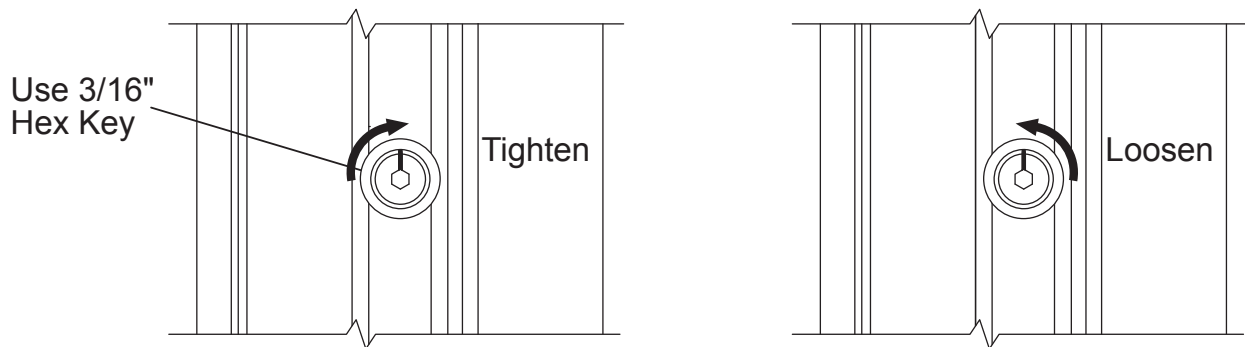

DETAIL 14 – In/Out

STEP 9B KEEPER ADJUSTMENT

Adjust left/right free swing clearance of window keepers as necessary.

1. Neutral as factory installed.





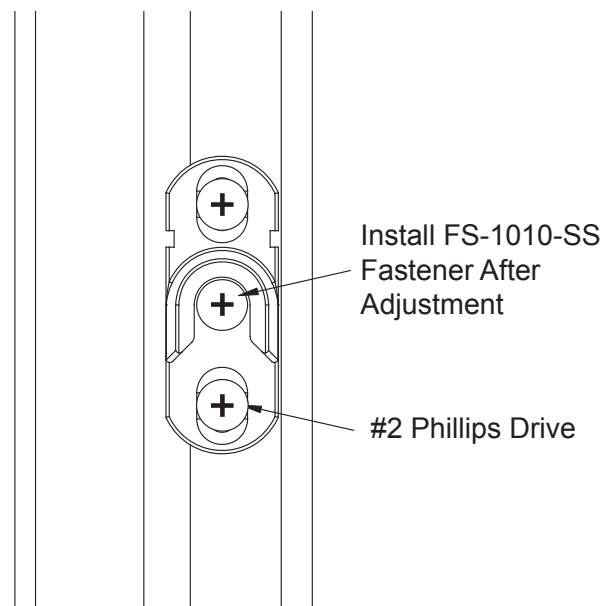

See **Detail 15**.

2. Use #2 Phillips drive to lightly loosen fastener.
 - A. Slide keeper to allow 1/8" clearance from locking point.
 - B. Using #2 Phillips drive, tighten fastener.
 - C. After final adjustment install FS-1010-SS to lock keeper in place.



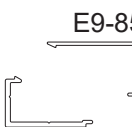
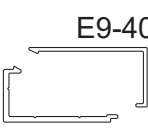
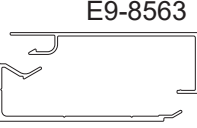
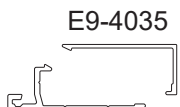
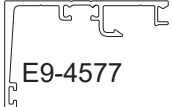

DETAIL 15 – Left/Right



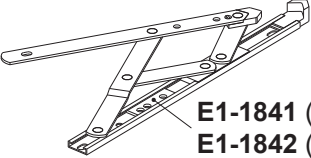
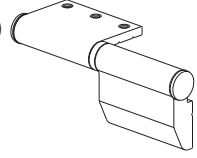
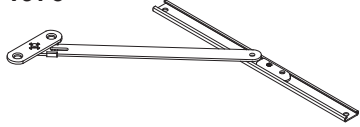
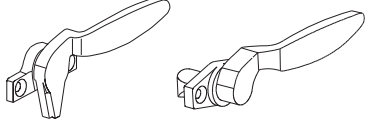

ANCHORING PARTS LIST

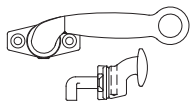
PART	DETAIL	DESCRIPTION	MATERIAL
STRAP ANCHOR	E1-1779 	4-1/2" length of E9-4529, used at indicated locations to add strength at anchor points.	ALUMINUM
TWIST ANCHOR	E1-1970 	Twist in anchor located as required. (Approved for up to Wind Zone 3 only)	GALVANIZED STEEL
ANCHOR FILLER	E9-4566 x 2 1/2" LG. 	Anchor filler for head, jamb, & sill at through anchors.	ALUMINUM
FRAME FILLER	E3-0038 x S.L. 	Frame filler for backer rod support at head, jamb, & sill	PVC
1" x 1-1/4" TRIM & CLIP	E9-4557  E9-4556	Trim & clip anchor for head, jamb, & sill.	ALUMINUM
1" x 1-11/16" TRIM & CLIP	E9-8537  E9-8538	Trim & clip anchor for head, jamb, & sill.	ALUMINUM
1" x 2" TRIM & CLIP	E9-4031  E9-4032	Trim & clip anchor for head, jamb, & sill.	ALUMINUM
1-1/8" x 3-1/2" TRIM & CLIP	E9-8562  E9-8563	Trim & clip anchor for head, jamb, & sill.	ALUMINUM
ANCHOR CLIP	E1-1922  E9-4035	2" long edge clip with trim cover for head, jamb, & sill.	ALUMINUM
HEAD/JAMB RECEPTOR	E9-4577  E9-4578	Head or Jamb Receptor. Used with E2-0051 bulb gasket.	ALUMINUM
SILL FLASHING	BE9-4583 	Sill flashing used with E2-0367 spacer. Optional sill extensions also available.	ALUMINUM

HARDWARE

PART	DETAIL	DESCRIPTION	MATERIAL
<p>4-BAR HINGES & LIMIT STOPS</p>	<p>4K-14207 (12") 4K-14208 (16", Casement Only) 5K-15284 (16", Project Out Only) E1-1957 (12" Egress, Casement Out Only)</p>  <p>E1-1841 (12", 45°) E1-1842 (16", 30°)</p>	<p>4-Bar Hinges allow for efficient and durable operation of projected and casement vents.</p> <p>Limit Stops allow vents to be opened to a preset maximum opening.</p>	<p>STAINLESS STEEL</p>
<p>BUTT HINGES</p>	<p>E1-1714 (LH) E1-1715 (RH)</p> 	<p>Butt Hinges are optional on casement outswing and inswing vents.</p>	<p>ALUMINUM</p>
<p>FRICTION ADJUSTER (STANDARD)</p>	<p>E1-1976</p> 	<p>Friction adjusters are standard on all butt hinge casement windows.</p>	<p>STAINLESS STEEL</p>
<p>CAM HANDLES</p>	<p>E1-1541 (RH) E1-1503 (RH) E1-1542 (LH) E1-1504 (LH)</p> 	<p>White Bronze Cam Handles for manual operation of vents. E1-1541 / E1-1542 are standard on outswings; E1-1503 / E1-1504 are standard on inswings.</p>	<p>WHITE BRONZE</p>
<p>CUSTODIAL CAM LOCKS (OPTIONAL)</p>	<p>E1-1596 E1-1517</p> 	<p>Custodial locks are offered for maintenance operation. These type of locks are used in place of cam handles.</p>	<p>WHITE BRONZE</p>
<p>POLE RING CAM HANDLE (OPTIONAL)</p>	<p>E1-1853 (LH) — INSWING E1-1854 (RH) — E1-1882 (LH) — E1-1881 (RH) — OUTSWING</p> 	<p>Pole Ring Handles are offered for windows inaccessible through normal means.</p>	<p>WHITE BRONZE</p>

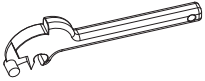
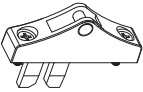
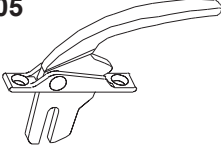
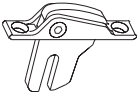

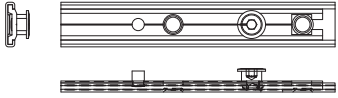
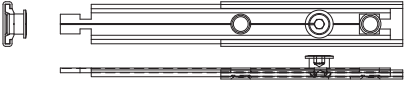
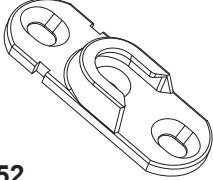
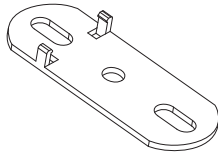

HARDWARE

PART	DETAIL	DESCRIPTION	MATERIAL
STANDARD MULTI-LOCK	<p>E1-1966</p> 	<p>Standard Multi-Locks with 4" handles are use to secure casement inswing and outswing and project out vents. Available for all windows.</p>	<p>Die Cast / Steel / Powder Coated or Plated</p>
EXTENDED MULTI-LOCK (OPTIONAL)	<p>E1-1994</p> 	<p>Optional Multi-Locks with 8" handles are use to secure casement inswing and outswing and project out vents.</p>	<p>Die Cast / Steel / Powder Coated or Plated</p>
CUSTODIAL MULTI-LOCK	<p>E1-2011 Handle</p>  <p>E1-2010 Lock</p> 	<p>Custodial Locks are offered for maintenance operation. These types of locks are used in place of E1-1966 multi-lock handles.</p>	<p>Die Cast / Steel / Powder Coated or Plated</p>
BRONZE CRAFT MULTI-LOCK (OPTIONAL)	<p>E1-1505</p> 	<p>Optional Multi-Lock handles are use to secure casement inswing and outswing vents.</p>	<p>WHITE BRONZE</p>
CUSTODIAL MULTI-LOCK (OPTIONAL)	<p>E1-1655</p> 	<p>Custodial Locks are offered for maintenance operation. These types of locks are used in place of E1-1505 multi-lock handles.</p>	<p>WHITE BRONZE</p>
STANDARD PULL HANDLE	<p>E1-1981</p> 	<p>Amesbury-Truth Pull</p>	<p>Satin Nickel / Chrome or Powder Coated</p>

HARDWARE

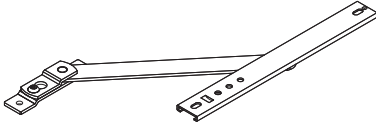
PART	DETAIL	DESCRIPTION	MATERIAL
<p>PULL HANDLE (OPTIONAL)</p>	<p>E1-1508</p> 	<p>Bronze Craft Pull</p>	<p>WHITE BRONZE</p>
<p>LOCK BAR BASE</p>	<p>E1-1954-xxxx</p> 	<p>5-1/4" to 48" 1 to 3 Points</p>	<p>ALUMINUM / STAINLESS STEEL</p>
<p>LOCK BAR EXTENSION</p>	<p>E1-1955-xxxx</p> 	<p>6" to 22" 1 Point</p>	<p>ALUMINUM / STAINLESS STEEL</p>
<p>INTERLOCK KEEPER</p>	<p>E1-1952</p> 		<p>DIE CAST / STAINLESS STEEL</p>
<p>KEEPER SHIM</p>	<p>E1-1953</p> 	<p>1/8" Thickness</p>	<p>PLASTIC</p>



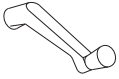

HARDWARE

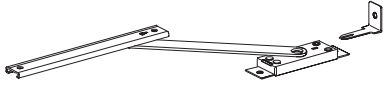
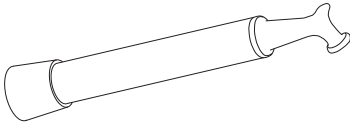
PART	DETAIL	DESCRIPTION	MATERIAL
4" LIMIT DEVICE (OPTIONAL, APPROVED FOR NEW YORK CITY)	E1-1904 	Keyed Limit Device meeting the fall revention requirements and approved for New York City. (Note: this hardware may be used in locations outside New York City.)	STAINLESS STEEL
STANDARD SINGLE ARM ROTO- OPERATORS	E1-1987 LH 8" E1-1988 RH 8" E1-1989 LH 14" E1-1990 RH 14" 	Single Arm Roto Operators are available as an option for Casement Outswing windows and include the E1-9932 handle. Available on all outswing windows.	Die Cast / Steel / Powder Coated or Plated
OPTIONAL SINGLE ARM ROTO- OPERATORS	E1-1590 RHR E1-1591 LHR 	Optional Bronze Craft Single Arm Operator	Composite, White Bronze, Stainless Steel
DUAL ARM ROTO- OPERATORS	E1-1991 5.5" E1-2012 7" E1-2013 9" E1-1992 11" 	Dual Arm Roto Operators are available as an option for Project Out windows and include the E1-9932 handle. Available on all outswing windows.	Die Cast / Steel / Powder Coated or Plated
STANDARD CRANK HANDLE	E1-9932 	For Use with Roto Operators	Die Cast / Steel / Powder Coated or Plated



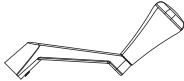

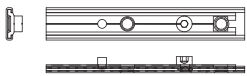
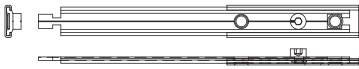

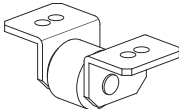
HARDWARE

PART	DETAIL	DESCRIPTION	MATERIAL
<p>KEYED LIMIT DEVICE (OPTIONAL)</p>	<p>E1-1572</p> 	<p>Permits the window to be opened a maximum of 6” and return to the closed position without the use of a tool or key. For maintenance or washing, key releases the window from the limit arm for reversal. When reversed, the window can be washed from the interior. Reclosing of window and re-engagement of limit arm is accomplished without key.</p>	<p>STAINLESS STEEL</p>
<p>PULL RING POLE ASSEMBLY (OPTIONAL)</p>	<p>E1-9930</p> 	<p>White bronze pull ring pole operates the pole ring cam handle. Available in lengths of 4’, 6’, and 8’.</p>	<p>WHITE BRONZE</p>







ACCESSIBLE WINDOW HARDWARE

DETAIL	PART NO.	DESCRIPTION	MATERIAL / FINISH
	H-1906 H-1907	For Inswing: Extended Handle (LH) Extended Handle (RH)	Die Cast / Steel / Powder Coated or Plated
	E1-1983	Large Crank Handle	Die Cast / Powder Coated or Plated
	E1-1995 10" E1-1996 12" E1-1997 16" E1-1998 20" E1-1999 24"	For Project Out: Loose Rivet 4-Bar Hinge	Stainless Steel / Mill
	E1-2001 -XXXX	Lock Bar Base 5-1/4" - 48" 1 - 3 Points	Aluminum / Stainless Steel
	E1-2002 -XXXX	Lock Bar Extension 6" - 22" 1 Point	Aluminum / Stainless Steel
	4K-18584	Keeper	Polished Stainless Steel
	E1-1751	Keeper Screw	Stainless Steel
	K-10639	Guide Roller	Stainless Steel / Acetal

GLAZING CHART

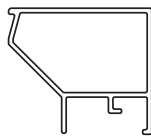
GLASS/PANEL DEPTH	EXTERIOR		INTERIOR	
	F.C.	BACKER TAPE	F.C.	GASKET
1/4"	1/8"	E2-0670 	1/4"	E2-0672 
1" FIXED	1/8"	E2-0670 	1/4"	E2-0672 
1" @ VENTS	1/8"	E2-0670 	1/4"	E2-0050 

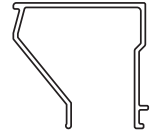
GLASS STOPS

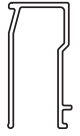
1/4" GLAZING		1" GLAZING	
PART NUMBER	DETAIL	PART NUMBER	DETAIL
E9-4521	 For All Vents	E9-4506	 For Fixed Glass
E9-4522	 For Fixed Glass	E9-5218	 For All Vents
E9-4523	 For Fixed Glass (Combination Window)	E9-5219	 For Casement Outswing Vent with Multi-Point Lock
		E9-4507	 For Fixed Glass (Combination Window)
		E9-4508	 For Fixed Glass (Combination Window)



101 Marietta Street NW
Suite 2100
Atlanta, Georgia 30303
www.ykkap.com