



**TABLE OF CONTENTS**

**20D/35D/50D STANDARD ENTRANCES**

**FRAMING MEMBERS (1/4 SIZE)..... Pages 2 to 5**

\*The latest installation instructions for this product are available at [www.ykkap.com](http://www.ykkap.com).

20D NARROW STILE    35D MEDIUM STILE    50D WIDE STILE

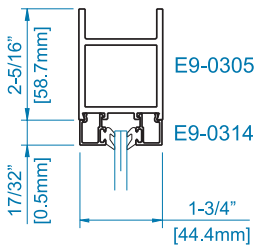
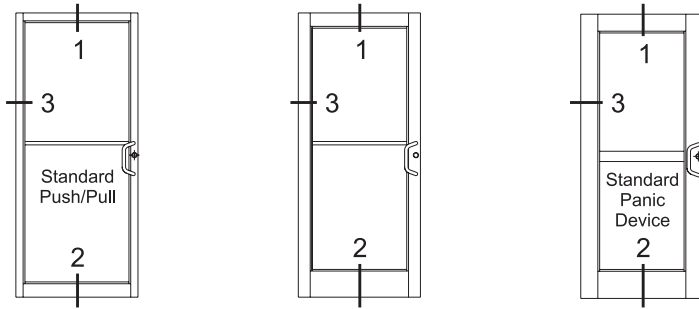
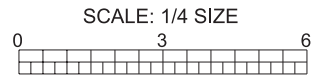

SECTION 1

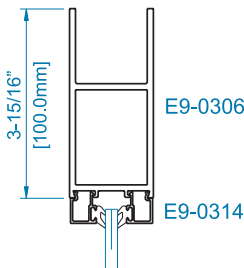

SECTION 1

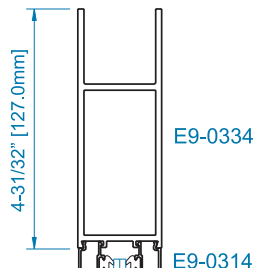

SECTION 1

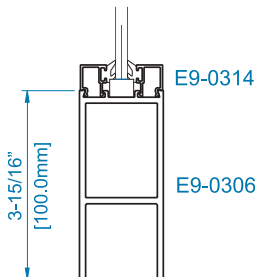

SECTION 2  
4" BOTTOM RAIL\*

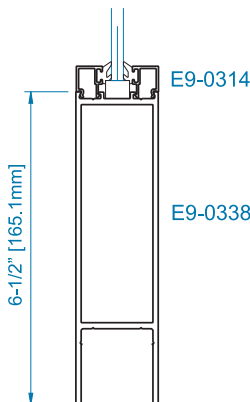

SECTION 2  
6-1/2" BOTTOM RAIL\*

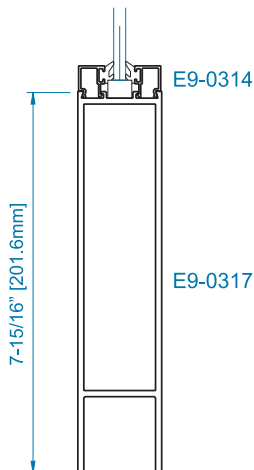

SECTION 2  
8" BOTTOM RAIL\*



SECTION 2  
10" BOTTOM RAIL\*

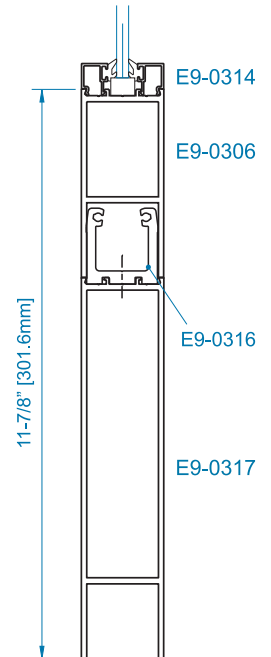

MANY BOTTOM  
RAIL HEIGHTS  
MAY BE OBTAINED  
BY STACKING

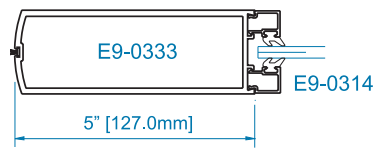
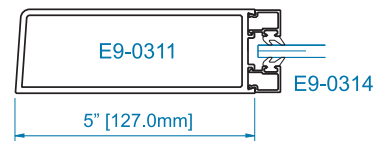
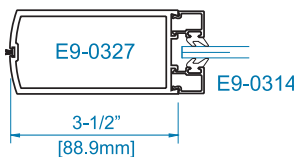
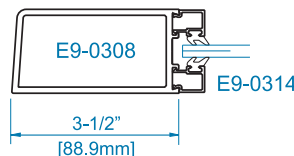
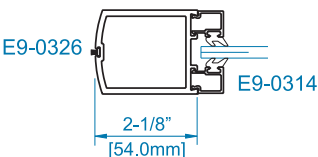
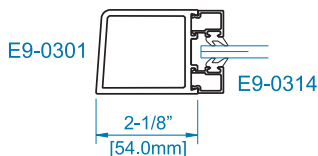

SINGLE ACTING

SECTION 3

DOUBLE ACTING

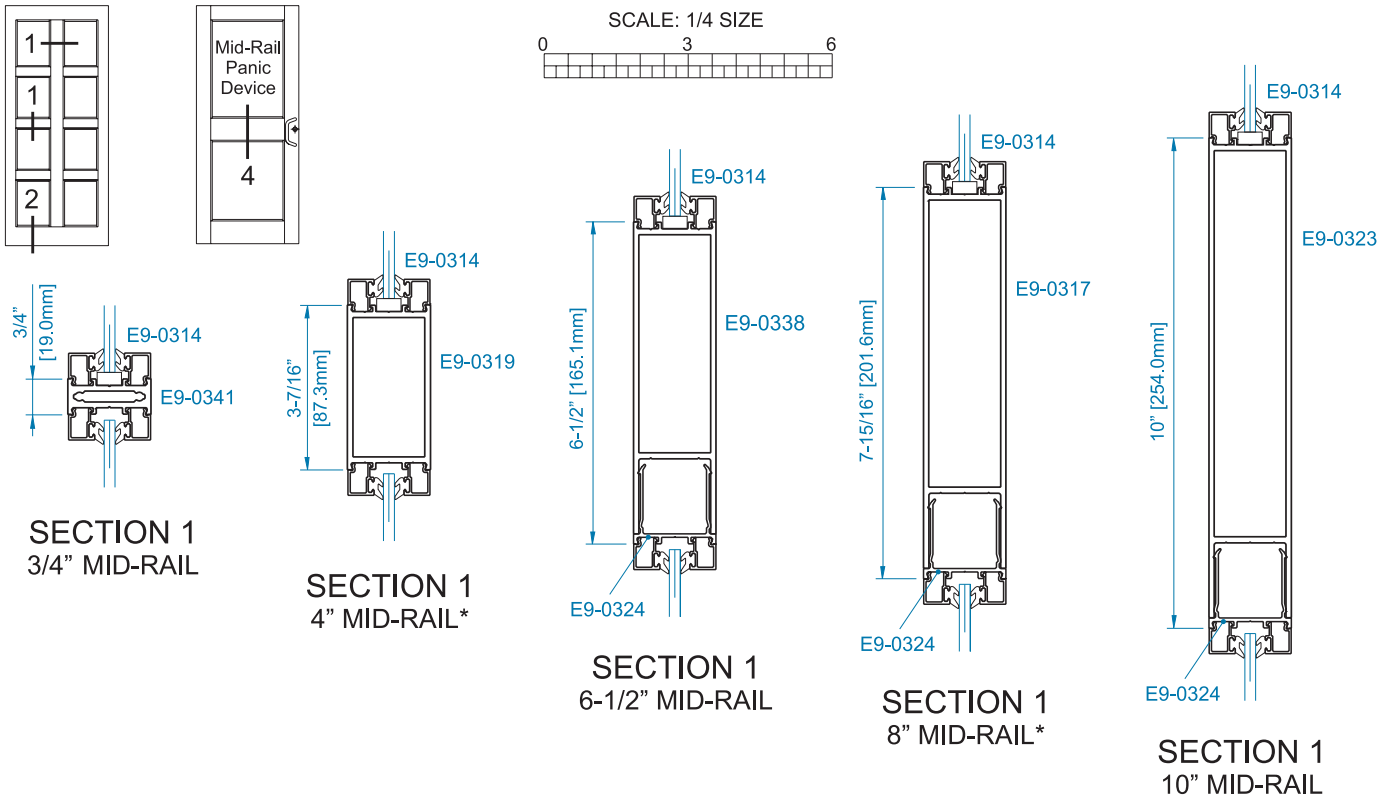

## OPTIONAL GLAZING

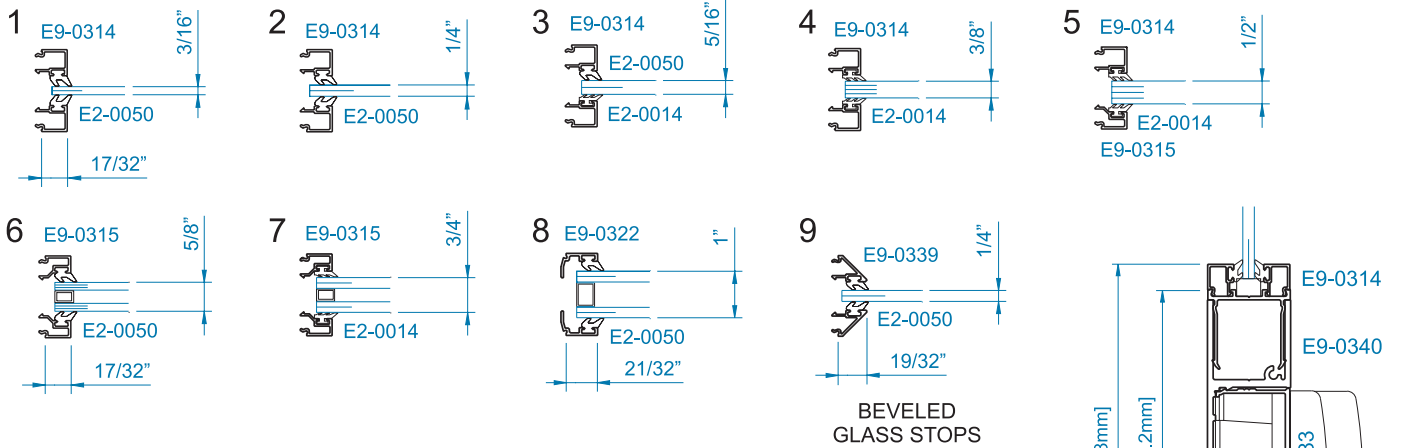

## SECTION 2 THRESHOLD OPTIONS

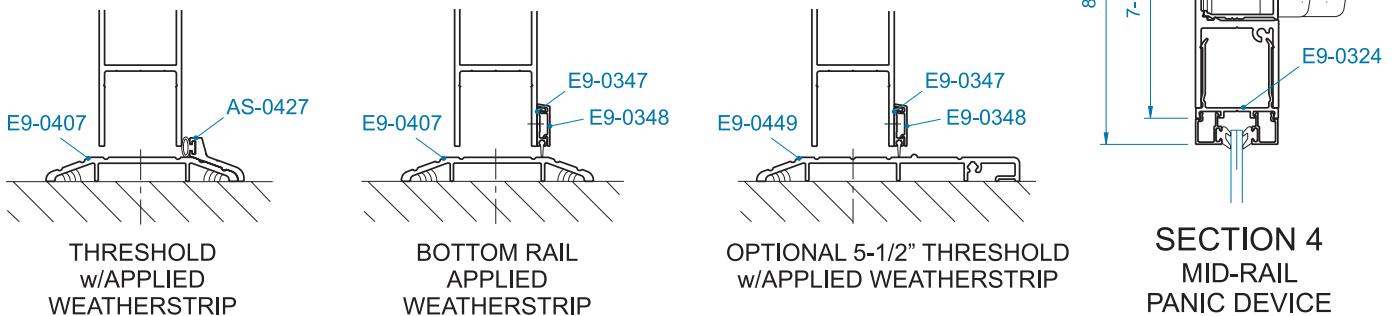

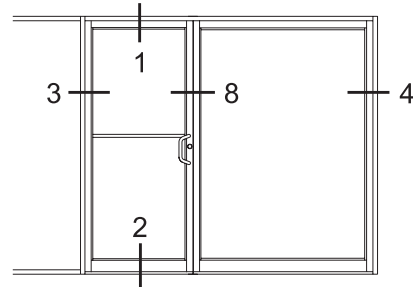
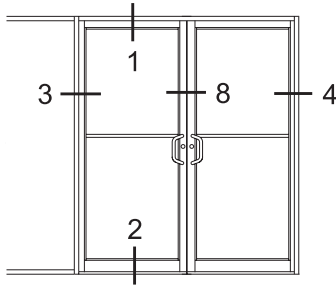
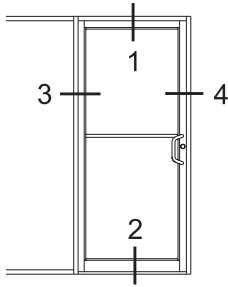

(AUTO SHOWROOM)

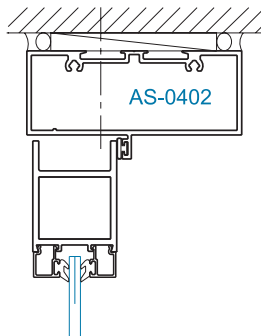

SECTION 1  
OFFSET HUNG

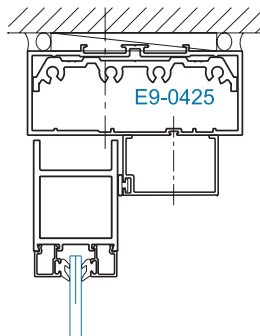

SECTION 1  
OFFSET HUNG (OHCC)

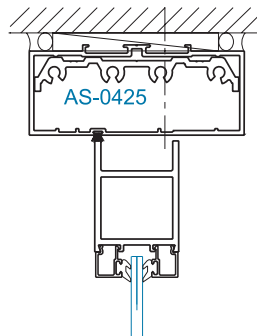

SECTION 1  
CENTER HUNG

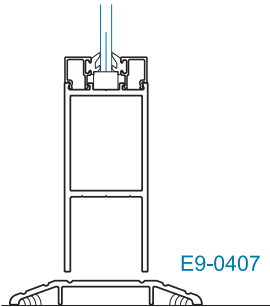

SECTION 2  
OFFSET HUNG

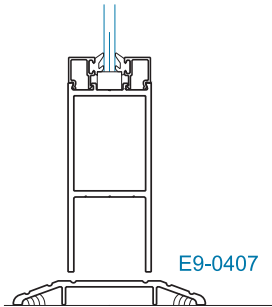

SECTION 2  
OFFSET HUNG (OHCC)

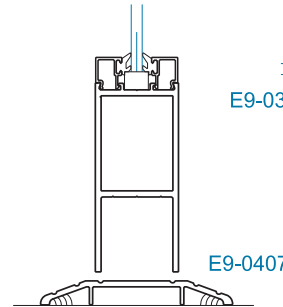

SECTION 2  
CENTER HUNG

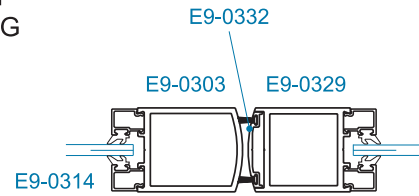

SECTION 8  
MEETING STILE

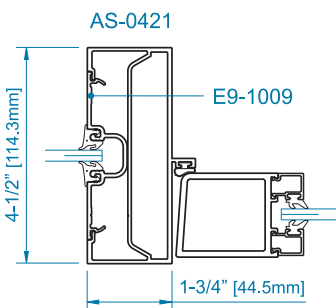

SECTION 3  
OFFSET HUNG

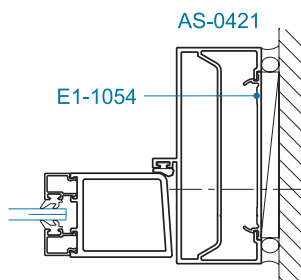

SECTION 4  
OFFSET HUNG

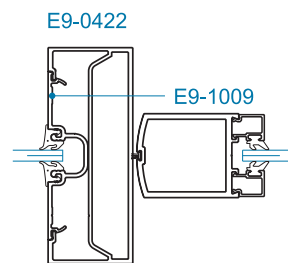

SECTION 3  
CENTER HUNG

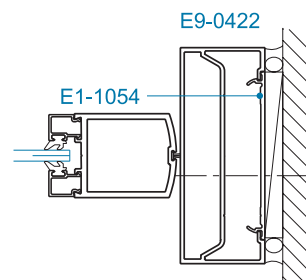

SECTION 4  
CENTER HUNG

**Note:** 20D Door is shown here with YES 45 FS Frame; Other doors are similar.  
See individual Design Manual Sections for 20D Door details with other framing systems.

SCALE: 1/4 SIZE

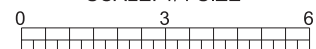

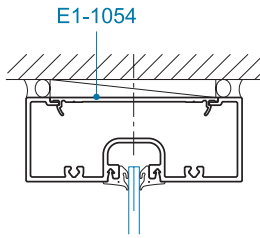

SECTION 5

E9-1003

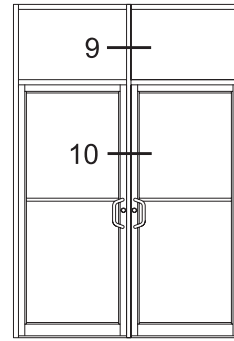
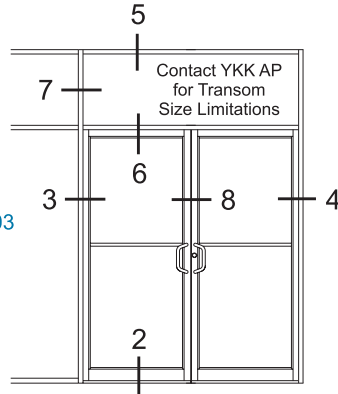

E9-0421  
E9-0422

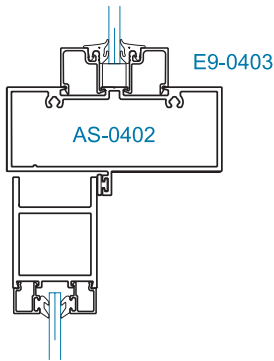
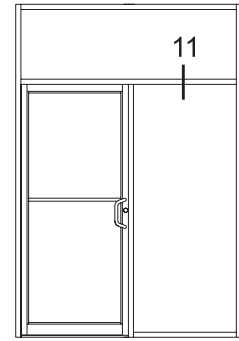

SECTION 6  
OFFSET HUNG

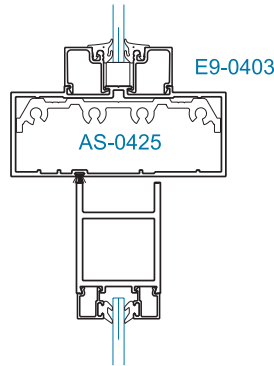

SECTION 6  
CENTER HUNG

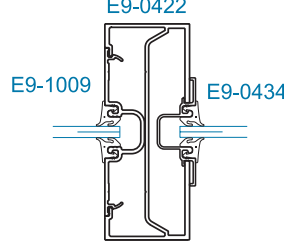

SECTION 7

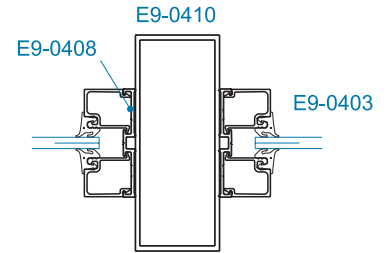

SECTION 9

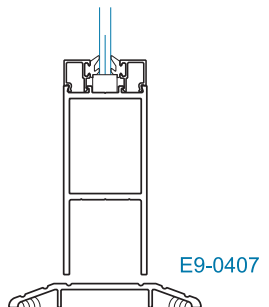

SECTION 2  
OFFSET HUNG

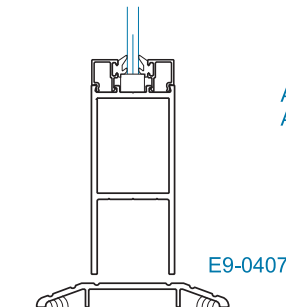

SECTION 2  
CENTER HUNG

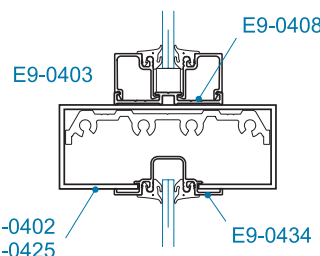

SECTION 11



SECTION 10

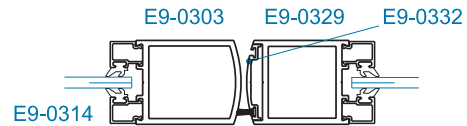

SECTION 8  
MEETING STILE

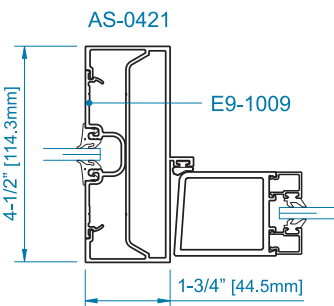

SECTION 3  
OFFSET HUNG

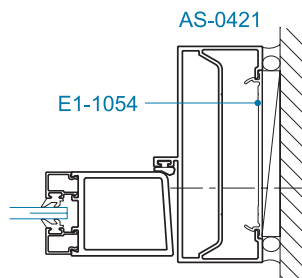

SECTION 4  
OFFSET HUNG

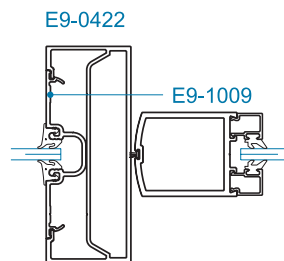

SECTION 3  
CENTER HUNG

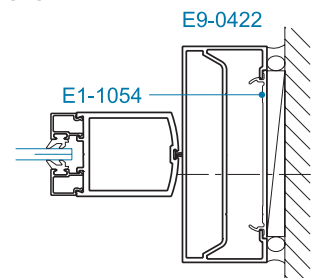

SECTION 4  
CENTER HUNG

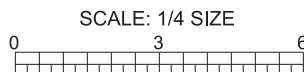

**Note:** 20D Door is shown here with YES 45 FS Frame; Other doors are similar. See individual Design Manual Sections for 20D Door details with other framing systems.